

# Assessing the Values of Cultural Heritage

Research Report  
The Getty Conservation Institute, Los Angeles



# **Assessing the Values of Cultural Heritage**

Research Report

Edited by Marta de la Torre

The Getty Conservation Institute, Los Angeles

*Project coordinator:* Marta de la Torre  
*Report editor:* Marta de la Torre  
*Design/Production coordinator:* Joe Molloy  
*Copy editor:* Sylvia Tidwell

Copyright © 2002 The J. Paul Getty Trust

The Getty Conservation Institute  
1200 Getty Center Drive, Suite 700  
Los Angeles, CA 90049-1684  
Telephone 310 440-7325  
Fax 310 440-7712  
Email [gci@getty.edu](mailto:gci@getty.edu)  
<http://www.getty.edu/gci>

The Getty Conservation Institute works internationally to advance conservation and to enhance and encourage the preservation and understanding of the visual arts in all of their dimensions—objects, collections, architecture, and sites. The Institute serves the conservation community through scientific research; education and training; field projects; and the dissemination of the results of both its work and the work of others in the field. In all its endeavors, the Institute is committed to addressing unanswered questions and promoting the highest possible standards of conservation practice.

The Institute is a program of the J. Paul Getty Trust, an international cultural and philanthropic institution devoted to the visual arts and the humanities that includes an art museum as well as programs for education, scholarship, and conservation.

# Contents

<b>Introduction</b>	
<i>Marta de la Torre and Randall Mason</i>	3
<b>Essays</b>	
Assessing Values in Conservation Planning: Methodological Issues and Choices <i>Randall Mason</i>	5
Anthropological-Ethnographic Methods for the Assessment of Cultural Values in Heritage Conservation <i>Setha M. Low</i>	31
Economic Valuation of Cultural Heritage: Evidence and Prospects <i>Susana Mourato and Massimiliano Mazzanti</i>	51
Numbness and Sensitivity in the Elicitation of Environmental Values <i>Theresa Satterfield</i>	77
Cultural Capital and Sustainability Concepts in the Economics of Cultural Heritage <i>David Throsby</i>	101
<b>Meeting Participants</b>	119

# Acknowledgments

THIS REPORT IS INDEBTED to the contributions of many who helped us define directions and identify critical issues. The work of Randall Mason and Erica Avrami at the start of this research set the stage for the discussions of a group of specialists that met at the Getty Conservation Institute in March 2000. The names of those participating in that meeting are included at the end of this report. We would like to acknowledge their valuable contribution and continued support of this project.



# Introduction

By Marta de la Torre and Randall Mason

THIS IS THE THIRD REPORT on the research on values and economics of cultural heritage which was started at the Getty Conservation Institute in 1995.<sup>1</sup> The early results of this project highlighted some issues fundamental to the field that were in need of further consideration. Among these were the lack of recognized and widely accepted methodologies for the assessment of cultural values, as well as the difficulties of comparing the results of economic and cultural values assessments.

The research we report in this publication starts to address these issues by focusing on methods of identifying, articulating, and establishing cultural significance.

*Cultural significance* is used here to mean the importance of a site as determined by the aggregate of values attributed to it. The values considered in this process should include those held by experts—the art historians, archaeologists, architects, and others—as well as other values brought forth by new stakeholders or constituents, such as social and economic values.<sup>2</sup>

Value has always been the reason underlying heritage conservation. It is self-evident that no society makes an effort to conserve what it does not value. Why, then, this current interest in values? Until recent times, the heritage field was relatively isolated, composed of small groups of specialists and experts. These groups determined what constituted “heritage” and how it should be conserved. The “right to decide” of these specialists was validated by the authorities who funded their work. There was a tacit agreement between the groups with the power to act.

In recent decades, the concept of what is heritage has evolved and expanded, and new groups have joined the specialists in its identification. These groups of citizens, of professionals from other fields, and of representatives of special interests arrive in the heritage field with their own criteria and opinions—their own “values”—which often differ from our own as heritage specialists.

This democratization is a positive development in our field and bears witness to the importance of heritage in today’s society. Nonetheless, this aperture has brought new considerations to the discussions and has made them much more complex. Today the opinions of experts are often a few among many, in an arena where it is recognized that heritage is multivalent and that values are not immutable. In this changed environment, the articulation and understanding of values have acquired greater importance when heritage decisions are being made about what to conserve, how to conserve it, where to set priorities, and how to handle conflicting interests.

As conservation professionals, we are familiar and comfortable with the assessment methods used by traditional heritage experts. However, to identify and measure “social” values, we must venture into new areas. The stakeholders of social values are usually members of the public who have not traditionally participated in our work or had their opinions taken into consideration. Today, as we recognize the importance of including all stakeholders in the process, we must turn to other disciplines to bring these new groups into the discussions.

The papers in this report present some tools that have been used in other fields and that hold promise for the tasks at hand. The first paper offers a review of the issues associated with the assessment of values in relation to cultural heritage. As an introduction to the methods presented in other contributions, it includes an overview of the “expert” methods already in use in the cultural field and identifies some of the challenges that lie ahead as we attempt to integrate these more traditional tools of the cultural field with others that must be imported to serve new needs. The anthropological and ethnographic methods presented by Setha M. Low are some of the methods introduced relatively recently to assess social values, and they are already being used to bring new groups of stakeholders into the values identification process. The field of environmental conservation has a relatively long tradition of consultation with a broad spectrum of stakeholders. Approaches from the environmental field are often held up as examples to be emulated in the heritage field, and

Theresa Satterfield's contribution analyzes the assessment tools most used in that discipline. Her balanced evaluation should help us as we consider importing into our field some of those methods.

Economists seem to have the most developed and widely accepted value assessment tools. However, as has been discussed in our earlier report on the economics of heritage,<sup>3</sup> these tools might not be as accurate in measuring cultural values as has been accepted in the past. A number of economists are now searching for ways of honing their tools to make them more useful in the heritage field. Susana Mourato and Massimiliano Mazzanti give us a detailed account of the tools used in their field and of the weaknesses and strengths of the various methods. Not surprisingly, recognizing that conservation is multidisciplinary, their conclusions point to collaboration with other disciplines.

Discussions of values, of how social contexts shape heritage and conservation, and of the imperative of public participation are issues that challenge conventional notions of conservation professionals' responsibilities. How to champion conservation principles (traditional ones, centered on the sanctity and inherent meaningfulness of material heritage) while managing an open, democratic process that may conclude by underselling conservation in favor of other social goals? This issue gets to the essential nature of the field and of conservation as a profession: "Are we advocates? Are we neutral professionals and experts?"

Conservation professionals are faced with two particular challenges arising out of these social and political contexts: challenges of power sharing and challenges of collaboration. Broader participation poses a challenge to the roles and responsibilities of conservation professionals: some suggest that bringing conservation policies and decisions in line with democratic values would undermine the authority of conservation professionals and would even amount to an abdication of professional responsibility. In other words, democratization of conservation decision making could contradict the professional devotion to conservation—what happens when the democracy of voices decides that a heritage site can be destroyed? Do we as conservation professionals have a right, or even a responsibility, to speak against the democratic will?

But the probability is not that actual decision making power will be democratized but, rather, that the process of value elicitation will be included. Democratization of the processes of consultation and assessment of

heritage values is not likely to be a threat to the sovereignty of the field, but it still requires a change of attitude and training. The inevitability of trade-offs and compromises and the respectful and meaningful gathering of different modes of valuing have to be recognized.

Using new methods from different fields means collaborating with more and different professionals (anthropologists and economists, for instance). Such collaboration raises questions about who is in charge of which part of the process. What are the relative roles and contributions and responsibilities of this different cast of characters? Does the conservation professional's role become that of an orchestrator of specialists? Or of one specialist among others? It seems that the conservation professional has moved to play the dual role of specialist and orchestrator. The tasks associated with the latter function call for new ways of thinking as well as for new skills.

In the last paper of this report, David Throsby provides us with some principles that can help to shape the new role of the conservation specialist. Advocating the principles of sustainability, we can moderate the discussions of a broad set of stakeholders while setting in place a number of filters that will promote decisions in this arena that protect the heritage while making it relevant to society.

The challenge ahead is to continue searching for the means to serve the public good by preserving material remains of the past.

---

## Notes

1. R. Mason, ed., *Economics and Heritage Conservation* (Los Angeles: Getty Conservation Institute, 1999); E. Avrami and R. Mason, eds., *Values and Heritage Conservation* (Los Angeles: Getty Conservation Institute, 2000).
2. Value can be defined simply as a set of positive characteristics or qualities perceived in cultural objects or sites by certain individuals or groups.
3. Mason, ed., *Economics and Heritage Conservation*.



# Assessing Values in Conservation Planning: Methodological Issues and Choices

By Randall Mason

CONSERVATION DECISIONS—whether they are concerned with giving a building “heritage” status, deciding which building to invest in, planning for the future of a historic site, or applying a treatment to a monument—use an articulation of heritage values (often called “cultural significance”)<sup>1</sup> as a reference point. Assessment of the values attributed to heritage is a very important activity in any conservation effort, since values strongly shape the decisions that are made. However, even though values are widely understood to be critical to understanding and planning for heritage conservation, there is little knowledge about how, pragmatically, the whole range of heritage values can be assessed in the context of planning and decision making. This paper aims to explore value assessment as a particular aspect of conservation planning and management.<sup>2</sup> Purposely broad in scope, what follows sets a context for the other contributions in this volume by relating issues of value and methodology, as seen by different disciplines, to the problems of conservation planning and policy.

Methodologically, assessment of heritage values is fraught with difficulties. These problems stem from factors such as the diverse nature of heritage values (there are many kinds of values—cultural, economic, political, aesthetic, and more—some of which overlap or compete), the fact that values change over time and are strongly shaped by contextual factors (such as social forces, economic opportunities, and cultural trends), the fact that these values sometimes conflict, and the wide variety of methodologies and tools for assessing the values (as used by a wide variety of disciplines and professions).

All models for values-based conservation include a step in which the significance of the site or building in question is established (Figure 1).<sup>3</sup> Too often, experts determine significance on the basis of a limited number of established criteria. As an alternative to this approach, this paper argues for a deliberate, systematic, and transparent process of analyzing and assessing all the values of heritage.

For purposes of planning and management, value assessment presents a threefold challenge: identifying all the values of the heritage in question; describing them; and integrating and ranking the different, sometimes conflicting values, so that they can inform the resolution of different, often conflicting stakeholder interests (Figure 2).

This paper explores issues, methodologies, and tools<sup>4</sup> applicable to value assessment, and its goal is to generate guidance for selecting appropriate methodologies (strategies) and tools (tasks) to assess heritage values as part of integrated conservation planning. This research goal stems from the realization that the conservation field, at present, is not very proficient at gauging all the values of heritage.

This paper proceeds from a few assumptions regarding the problems of value assessment in conservation planning:

- heritage conservation is best understood as a sociocultural activity, not simply a technical practice; it encompasses many activities preceding and following any act of material intervention;
- it is important to consider the contexts of a heritage conservation project—social, cultural, economic, geographical, administrative—as seriously and as deeply as the artifact/site itself is considered;
- the study of values is a useful way of understanding the contexts and sociocultural aspects of heritage conservation;
- heritage values are, by nature, varied, and they are often in conflict;
- traditional modes of assessing “significance” rely heavily on historical, art historical, and archaeological notions held by professionals, and they are applied basically through interdisciplinary means;
- consideration of economic values, a strong force shaping heritage and conservation, is outside the traditional purview of conservation professionals, and their integration with cultural values presents a particular challenge;

Figure 1 Planning process methodology.

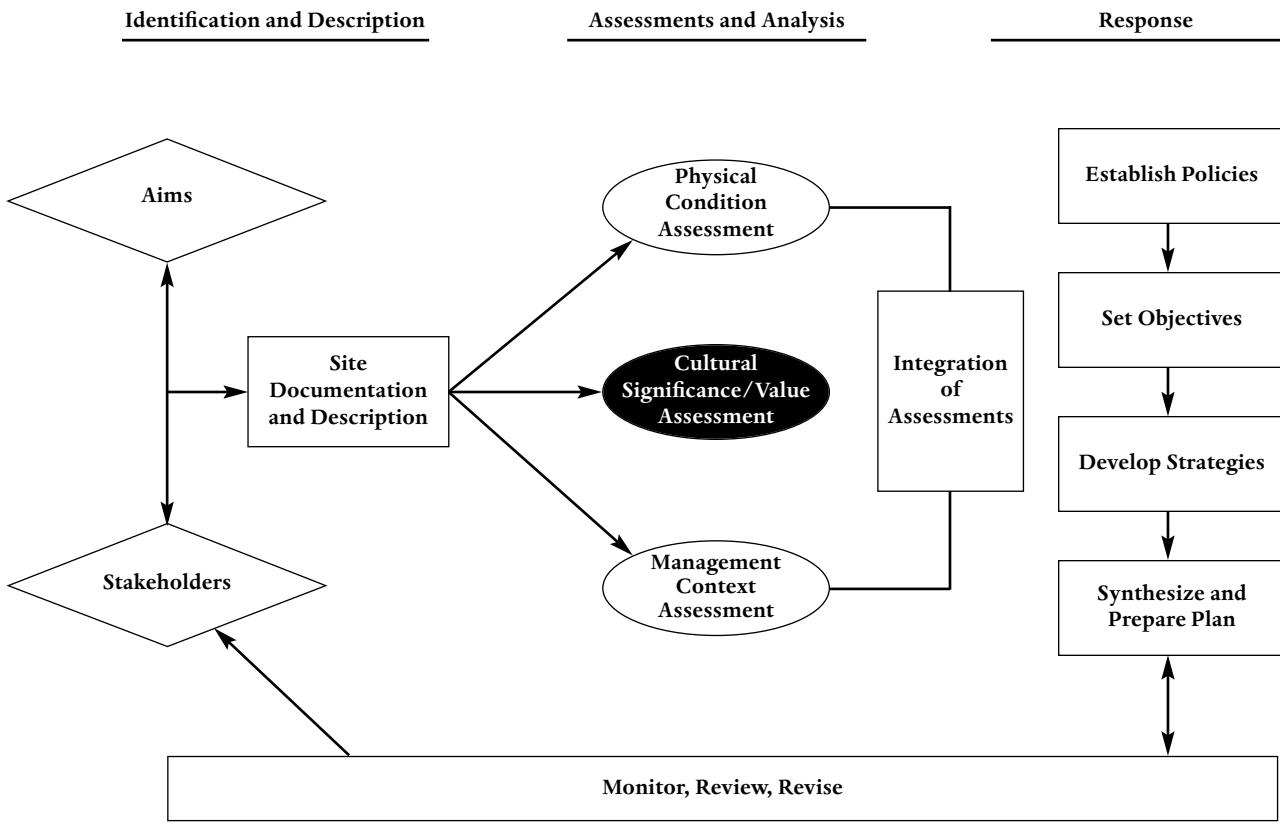

- no single discipline or method yields a full or sufficient assessment of heritage values; therefore, a combination of methods from a variety of disciplines should be included in any comprehensive assessment of the values of a heritage site;

- conservation management and planning should employ a strategy of inclusiveness by calling on different disciplines and bringing in the views of “insiders” and “outsiders” in the planning process;

- a more encompassing assessment of heritage values, and integration of these different values, will lead to better, more sustainable conservation planning and management;

- the test of more effective conservation planning is its responsiveness to the needs of stakeholders, communities, and contemporary society.

In the remaining sections of this paper, four specific questions are explored (in the same sequence that one would encounter them in a planning process):

- *Characterizing values:* How can the wide range of heritage values be identified and characterized in a way that is relevant to all the disciplines and stakeholders involved?

- *Methodological issues and strategies for assessing heritage values:* What kinds of methodological strategies and specific assessment tools are available and appropriate for assessing heritage values?

- *Tools for eliciting heritage values:* How can the views of the many parties with a stake in a heritage site be accommodated in the conservation planning process, including its specific value-assessment phase?

- *Integrating assessments and guiding decision making:* Once the range of heritage values has been articulated, how can they inform decision making?

## Characterizing Values

As a prelude to specific discussions of value assessment, this section delves into characterizing the notion of value as a guiding idea in heritage conservation. One of the core assumptions of this paper is the usefulness of the “values” perspective to illuminate conservation and management planning issues and make these activities more effective.

## Values in Conservation

Values is most often used in one of two senses: first, as morals, principles, or other ideas that serve as guides to action (individual and collective); and second, in reference to the qualities and characteristics seen in things, in particular the positive characteristics (actual and potential).<sup>5</sup>

This paper is concerned directly with the second definition. The perspective taken here is an anthropological one, and it values the attempt to understand the full range of values and valuing processes attached to heritage—as opposed to the normative, art historical view common in the conservation field, which a priori privileges artistic and historical values over others.

Figure 2 The cultural significance/value assessment process. This three-part model of value assessment is a more detailed rendering of the “Cultural significance/value assessment” oval occupying the center of the planning process methodology (Figure 1). With the different parts of the value-assessment process identified, planners can apply a logical sequence of tasks to generate and collect knowledge about values and use this within the overall planning process.

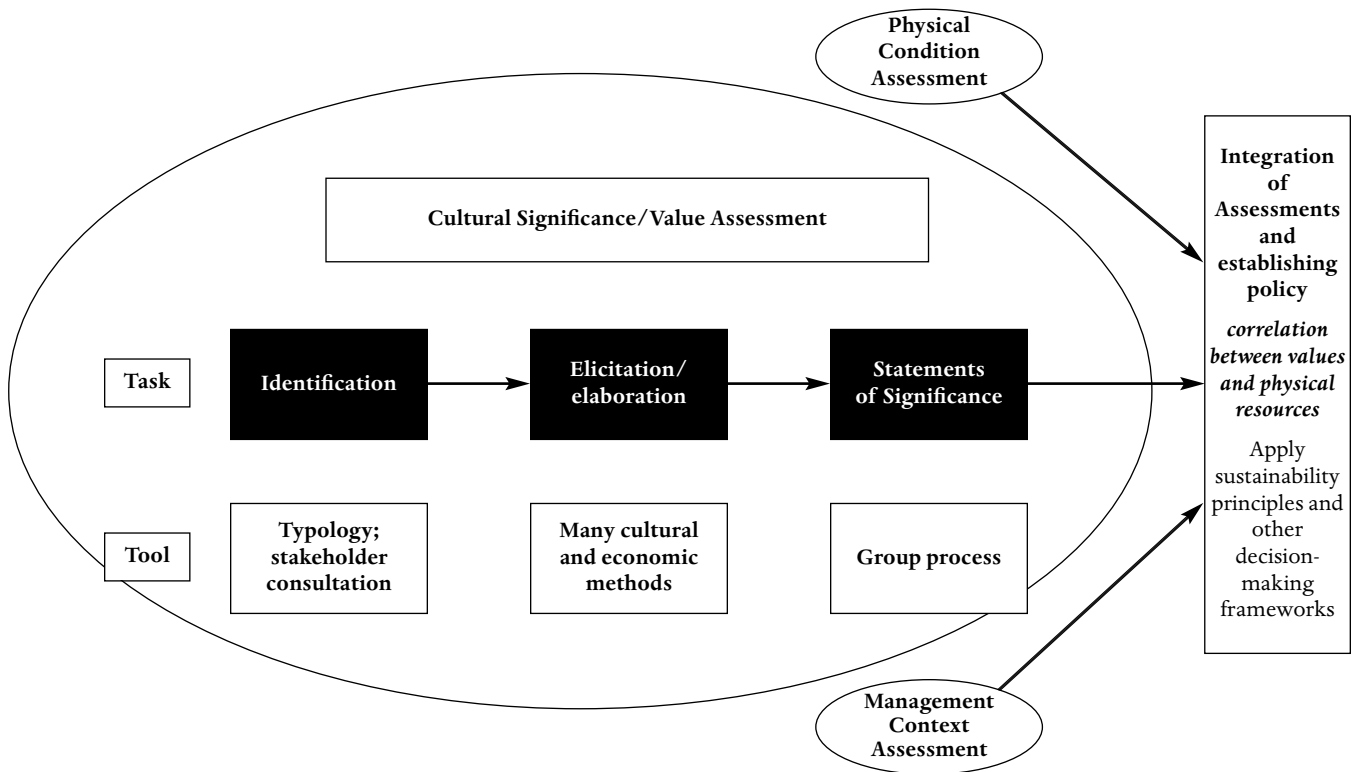

Value suggests usefulness and benefits. Heritage is valued not as an intellectual enterprise but because (as one aspect of material culture) it plays instrumental, symbolic, and other functions in society. This will become clearer below, as different types of heritage value are described.

In the sphere of material heritage, the simple question of “What is the value of this thing?” provokes a whole range of answers, all meaningful and legitimate—and therein lies an important issue. In a given moment, a given heritage site, building, or object has a number of different values ascribed to it—heritage is multivalent. As an example, take a hypothetical old church: it has spiritual value as a place of worship; it has historical value because of the events that have transpired there (or simply because it is old); it has aesthetic value because it is beautiful and a fine work of architecture; it has economic value as a piece of real estate; it has political value as a symbolic representation of a certain kind of social order; and so on. What’s more, the different values that can be discerned correspond to different stakeholders or expert observers. This multivalence is an essential quality of heritage and, as argued below, logically suggests a pluralistic, eclectic approach to value assessment.

A second important insight about heritage values is that they are contingent, not objectively given. The values of heritage are not simply “found” and fixed and unchanging, as was traditionally theorized in the conservation field (i.e., the notion of heritage values being intrinsic). Values are produced out of the interaction of an artifact and its contexts; they don’t emanate from the artifact itself. Values can thus only be understood with reference to social, historical, and even spatial contexts—through the lens of who is defining and articulating the value, why now, and why here? For conservation professionals, this requires some substantial rethinking of the kinds of research and knowledge that are needed to support conservation. Traditionally, values were articulated by experts’ analysis of heritage as a work of art or a record of the past. Only recently has the conservation field begun to embrace such factors as economics, cultural change, public policy, and social issues—and they have yet to be fully integrated into the field.

“Where do values come from?” has been a question of considerable debate. Should material culture recognized as heritage be said to have some intrinsic value (unchanging and universal), or should heritage value be seen as radically and essentially extrinsic and constructed

out of the various social contexts of the object, building, or site? The answer seems to lie somewhere in between: value is formed in the nexus between ideas and things. The viewpoint adopted in this research borrows from both ends of this spectrum: on one hand, everything anointed as heritage will, by definition, have some kind of heritage value (aside from whether the value is primarily historic, artistic, or social). In other words, anything defined as heritage is said to intrinsically and tautologically possess some kind of heritage value (though the nature of that value is not intrinsically given). On the other hand, the contingent / constructed viewpoint rightly points to value-formation factors *outside* the object itself and emphasizes the important social processes of value formation. Recognizing the fundamental contingency of heritage values does not preclude the possibility of some values that are universally held (or nearly so). These socially constructed values—think of the Great Pyramids, for instance—are seen as universal because they are so widely held, not because they are objective truths.

### Value Typologies

The pragmatic questions at hand are: how can a wide range of heritage values be identified and characterized in a way that (1) informs policies and planning decisions, and (2) is relevant to all the disciplines and stakeholders involved?

Values in heritage conservation have traditionally been treated in one of two ways: (1) one kind of value predominates and blots out consideration of others; or (2) values are treated as a black box, with all aspects of heritage value collapsed into “significance.” The first treatment is problematic because whole categories of value can be excluded a priori. For instance, if the economic use value of a historic site is allowed to predominate, the tourism activity that maximizes those economic values can quickly obscure or erode the site’s historical values (visitor traffic destroys historic context and even the resources themselves, perhaps by careless visitors climbing on ruins or taking fragments as souvenirs). The second kind of treatment (the “black box”) is problematic because in collapsing all values to an aggregate statement of significance, the different types of heritage value are mystified or rendered secondary and are thus neglected. An example of this would be a historic church or mosque that is classified by authorities and understood by the secular public primarily as a building of historical or artistic significance; this circumstance can obscure another

**Table 1** Summary of heritage value typologies devised by various scholars and organizations (Reigl 1982; Lipe 1984; for the Burra Charter, Australia ICOMOS 1999; Frey 1997; English Heritage 1997).

Reigl (1902)	Lipe (1984)	Burra Charter (1998)	Frey (1997)	English Heritage (1997)
Age	Economic	Aesthetic	Monetary	Cultural
Historical	Aesthetic	Historic	Option	Educational and academic
Commemorative	Associative-symbolic	Scientific	Existence	Economic
Use	Informational	Social (including spiritual,	Bequest	Resource
Newness		political, national, other cultural)	Prestige Educational	Recreational Aesthetic

important value of the building as a sacred site of worship. By hanging the determination of significance too much on the artistic value of the religious building, the other (“secondary”) value of religious worship or even of musical performance can be eroded, even though it would not be difficult to conserve all of these values simultaneously.

There are so many different kinds of values, and the interactions among them are so complex, that a more effective way of treating this issue has to begin with a clear, effectively neutral, agreed-upon way of characterizing different types of heritage value—as seen by the wide variety of stakeholders in conservation efforts. **A typology of heritage values would be an effective guide to characterization and would move conservation stakeholders closer to having a lingua franca in which all parties’ values can be expressed and discussed.** By use of such a typology—a framework that breaks down significance into constituent kinds of heritage value—the views of experts, citizens, communities, governments, and other stakeholders can be voiced and compared more effectively.

Any effort to break down and describe the values attached to a particular heritage site immediately encounters conceptual and practical difficulties. The different articulations of heritage value (in terms of historical association, artistic merit, or dollars) are at some level different expressions of the same qualities, seen through different eyes. The units and yardsticks used by art historians, sociologists, and economists, for instance, are not readily comparable or translatable. In addition to these differences in epistemology and modes of expression, there are real differences in how a particular type of value is assessed by different stakeholders—for instance, the economic value as assessed by a corporation operating and owning a heritage site, versus a typical resident of a

nearby village. A third difficulty in characterizing values lies in the fact that values are always changing in some respect, and we should expect this as part of the essential, social nature of heritage. For all these reasons, heritage values cannot be objectively measured and broken down in the same sense that a chemist, for instance, can analyze and break down a compound to determine its constituent parts.

While the subjectivity and contingency of heritage values make it difficult to establish a clear framework or even a nomenclature of values (akin to a chemist’s elements and compounds), this is precisely what is needed to facilitate the assessment and integration of different heritage values in conservation planning and management. **So the concept of values needs to be broken down and defined in a typology, at least provisionally.** By suggesting a typology in the remainder of this section, we wish to highlight its provisional nature. It is not claimed that this (or any) typology will be appropriate for all sites or situations—it is simply an attempt to create a common starting point from which a modified typology can be constructed in a variety of heritage planning situations.

The practical aspects of discussing typologies should also be emphasized. Establishing a typology of values will facilitate discussion and understanding of the different valuing processes at play in heritage conservation. **This kind of knowledge ultimately can guide practitioners’ choices of appropriate assessment methods for a wide range of heritage values.** Typologies also constitute a first-order research tool, ordering and organizing knowledge so that research builds on itself—it keeps practitioners from having to continually reinvent the wheel. The benefit of using a common typology of values is that it lends comparability to the evaluation of different projects.

This is an important goal of research on conservation planning—establishing some grounds for comparison among many types of heritage projects and deriving best-practices guidance applicable to many different situations.

Finally, the typology is both an analytical tool and a way to advance wider participation in the planning process.

Value categories correspond to different stakeholder positions voiced in heritage debates and projects, and devising and debating the typology are themselves means of stimulating participation.

As one would expect, given the conceptual complexities outlined so far, finding agreement on a typology or a nomenclature of heritage values has proven problematic. Nearly everyone interested in heritage—citizen, scholar, writer, professional, or organization—has a slightly different conception, advanced from a particular perspective, of how to describe these characteristics of heritage. Consider the sampling of heritage value typologies devised by different scholars and organizations and summarized in Table 1.<sup>6</sup> In most instances, they describe the same pie, but slice it in subtly different ways.

Typologies implicitly minimize some kinds of value, elevate others, or foreground conflicts between the cultivation of certain values at the expense of others. In the Burra Charter, for instance, economic values are minimized because they are seen as derived from cultural and historical values and are therefore given secondary consideration.

It is apparent that there are several distinct, if not fully separable, categories of heritage value—economic, historical, spiritual, political, educational, aesthetic, artistic. If one were to map these value schemata, there would be a great deal of overlap even between such different frameworks as Frey’s (from economics) and Reigl’s (from art history). The typology suggested in English Heritage’s recent paper on sustainability is perhaps the most comprehensive and balanced (English Heritage 1997). This breakdown is well oriented to conservation practice because the value categories focus on how heritage is used and valued (contingently, and by people other than elites and experts), whereas many other typologies resonate more with connoisseurship and professional values and are strongly influenced by the notion of heritage’s intrinsic value.

A broad distinction is often made between economic and cultural values as the two primary meta-categories of heritage value. This distinction has served as a starting point for the research undertaken by the Getty Conservation Institute on values-related issues most rele-

Table 2 Provisional typology of heritage values.

Sociocultural Values	Economic Values
Historical	Use (market) value
Cultural/symbolic	Nonuse (nonmarket) values
Social	Existence
Spiritual/religious	Option
Aesthetic	Bequest

vant to conservation. However, defending a hard-and-fast separation of economic and cultural spheres is untenable. Economic behavior cannot be beyond, or separate from, culture, which by definition is “ways of living together” or attitudes and behaviors passed on. Indeed, economics is one of the most dominant (sub)cultures—ways of living together—in many societies.

Nevertheless, the economic-cultural distinction is widely shared and remains a very useful analytic convenience. The economic-cultural distinction resonates because: (1) it highlights privatization and the influence of market logic into ever more spheres of social life, a most pressing contemporary social issue; (2) it connects to traditional debates around notions of economic base and cultural superstructure and their relation in modern societies; and (3) perhaps most important for our present purposes, economic and cultural spheres represent two quite distinct attitudes/perspectives toward the subject of values and valuing.

### Provisional Typology

The provisional typology shown in Table 2—which is neither exhaustive nor exclusive—is offered as a point of departure and discussion.

This typology includes the kinds of value most often associated with heritage sites and conservation issues, but it does not assume that every heritage site has every type of value. The working assumption behind the typology presented here is that these categories encompass most of the heritage values that shape decision making and that must be considered in conservation planning and management. The danger in using such a typology is that it may suggest that one framework of values speaks equally well to all heritage sites, issues, and cultural milieus. If it were used in this normative way, and as an a

priori framework, it would prefigure too much about the values of a heritage site. It is reiterated, therefore, that any value typology should serve only as a starting point and that value types will have to be adjusted and revised for each project/setting.

The two major categories—sociocultural and economic—do not actually refer to different, discrete sets of values. Economic and cultural are two alternative ways of understanding and labeling the same, wide range of heritage values. There are substantial overlaps between the values each column in Table 2 helps identify. The major difference between them resides in the very different conceptual frameworks and methodologies used to articulate them.<sup>7</sup>

The same point must be made concerning the subcategories within the “sociocultural values” group; they are not distinct and exclusive; in fact, they overlap quite extensively. This intermingling contrasts with the categories of the “economic values” column, which are intended to be distinct and exclusive of one another.

#### SOCIOCULTURAL VALUES

Sociocultural values are at the traditional core of conservation—values attached to an object, building, or place because it holds meaning for people or social groups due to its age, beauty, artistry, or association with a significant person or event or (otherwise) contributes to processes of cultural affiliation.

The types of sociocultural values outlined below overlap. For instance, a quality defined as a spiritual/religious value (a congregation’s ongoing use of a historic church, for example) could also be defined as a historical value (the history of generations worshiping in the church and playing a role in the development of the surrounding community) or as an artistic value (the particular design of the building and its furnishings) or as a social value (used for nonreligious gatherings—for instance, a holiday concert or soup kitchen). While these uses are closely related, it is important to understand these as different values, because they correspond to different ways of conceptualizing the value of the heritage, to different stakeholder groups, and therefore to different bases for making management or conservation decisions.

Notice that there is no separate category for political value. The reason: all values attributed to heritage are, in fact, political, in that they are part of the power struggles and exertions that determine the fate of heritage. Values occupy center stage when it comes to the decisions—the politics—about the conservation of heritage.

#### Historical Value

Historical values are at the root of the very notion of heritage. The capacity of a site to convey, embody, or stimulate a relation or reaction to the past is part of the fundamental nature and meaning of heritage objects. Historical value can accrue in several ways: from the heritage material’s age, from its association with people or events, from its rarity and/or uniqueness, from its technological qualities, or from its archival/documentary potential.

There are two important subtypes of historical value that merit mention. Educational/academic value is a type of historical value. The educational value of heritage lies in the potential to gain knowledge about the past in the future through, for instance, archaeology or an artist’s creative interpretation of the historical record embodied in the heritage. Artistic value—value based on an object’s being unique, being the best, being a good example of, being the work of a particular individual, and so on—is also a type of historical value.

#### Cultural/Symbolic Value

History and heritage are core elements of all cultures—the ideas, materials, and habits passed through time—so cultural values are, like historical value, a part of the very notion of heritage. There is no heritage without cultural value. Cultural values are used to build cultural affiliation in the present and can be historical, political, ethnic, or related to other means of living together (for instance, work- or craft-related). As used in this typology, cultural/symbolic value refers to those shared meanings associated with heritage that are not, strictly speaking, historic (related to the chronological aspects and meanings of a site).

Political value—the use of heritage to build or sustain civil relations, governmental legitimacy, protest, or ideological causes—is a particular type of cultural/symbolic value. These values stem from the connection between civic/social life and the physical environment and from the capacity of heritage sites in particular to stimulate the kind of positive reflection and political behavior that builds civil society. Political/civil value can be manifestly symbolic, or it can stem from research and understanding of how heritage sites are created and evolve, and from learning about who has shaped the environment. Like all heritage values, political value can be interpreted through a positive lens—as a key contributor to civil society—or, more cynically, it can be interpreted as a political tool used to enforce national culture, imperialism, postcolonialism, and so on.

Craft- or work-related values are often very important aspects of heritage. A building embodies the methods used to design and make it, and the values relating to the process of making and building are often separate from (or lost among) more static historical or aesthetic values.

This category also includes heritage values used to stimulate ethnic-group identity, in cases in which the group does not have a strong religious aspect.

#### *Social Value*

The concept of social value follows closely the notion of “social capital,” a widely used concept in the social science and development fields. The social values of heritage enable and facilitate social connections, networks, and other relations in a broad sense, one not necessarily related to central historical values of the heritage. The social values of a heritage site might include the use of a site for social gatherings such as celebrations, markets, picnics, or ball games—activities that do not necessarily capitalize directly on the historical values of the site but, rather, on the public-space, shared-space qualities. The kinds of social groups strengthened and enabled by these kinds of values could include everything from families to neighborhood groups to ethnic groups to special interest groups (e.g., bird-watchers).

Social value also includes the “place attachment” aspects of heritage value. *Place attachment* refers to the social cohesion, community identity, or other feelings of affiliation that social groups (whether very small and local, or national in scale) derive from the specific heritage and environment characteristics of their “home” territory.

#### *Spiritual/Religious Value*

Heritage sites are sometimes associated or imbued with religious or other sacred meaning. These spiritual values can emanate from the beliefs and teachings of organized religion, but they can also encompass secular experiences of wonder, awe, and so on, which can be provoked by visiting heritage places.

#### *Aesthetic Value*

Aesthetic value is widely agreed to be a category of socio-cultural value, though it refers to a wide range of qualities. In the main, *aesthetic* refers to the visual qualities of heritage. The many interpretations of beauty, of the sublime, of ruins, and of the quality of formal relationships considered more broadly have long been among the most important criteria for labeling things and places as heritage. The design and evolution of a building, object, or site can be another source of aesthetic value. It is also

argued that the category of the aesthetic can be interpreted more widely to encompass all the senses: smell, sound, and feeling, as well as sight. Thus, a heritage site could be seen as valuable for the sensory experience it offers. Aesthetic value is a strong contributor to a sense of well-being and is perhaps the most personal and individualistic of the sociocultural value types.

#### ECONOMIC VALUES

Economic valuing is one of the most powerful ways in which society identifies, assesses, and decides on the relative value of things. The papers in this volume by David Throsby and by Susana Mourato and Massimiliano Mazzanti beautifully characterize and analyze in some detail the notion of value and valuing as seen by the discipline of economics. Economic values overlap a great deal with the sociocultural values (historical, social, aesthetic, and so on) described above, and they are distinguished most because they are measured by economic analyses. In other words, economic values are different because they are conceptualized in a fundamentally different way (according to a fundamentally different epistemology, one not commensurable with the narrative epistemologies used for sociocultural values). According to neoclassical economic theory, economic values are the values seen primarily through the lens of individual consumer and firm choice (utility) and are most often expressed in terms of price. Not all economic values, however, are measured in terms of market prices.

Economic values stemming from the conservation of heritage are often, by definition, understood to be a public good—reflecting collective decisions rather than individual, market decisions—and are therefore not captured by market price measures. There is an important distinction between what values can legitimately be represented in terms of price (privately held values, which can be traded in a market) and what factors shape resource allocation decisions (public ones, collectively held, and provided outside of markets). Accounting for these gaps is one of the goals of the research effort. A diverse set of economic valuation methods, therefore, will be needed to span this gap between private/market values and public/nonmarket values.

The different economic values outlined here, and the relations among them, are summarized in the paper by Mourato and Mazzanti in the present volume.<sup>8</sup> The main distinction they draw is related to use versus nonuse values, corresponding to the types of economic values measured through markets and outside of markets.<sup>9</sup>



### *Use Value (Market Value)*

Use values are market values<sup>10</sup>—the ones most easily assigned a price. Use values of material heritage refer to the goods and services that flow from it that are tradable and priceable in existing markets. For instance, admission fees for a historic site, the cost of land, and the wages of workers are values. Because they are exchanged in markets, these values can be easily expressed in terms of price, and they are susceptible to economists' many analytical tools based on neoclassical theory.

### *Nonuse Value (Nonmarket Value)*

Nonuse values are economic values that are not traded in or captured by markets and are therefore difficult to express in terms of price. For instance, many of the qualities described as sociocultural values are also nonuse values. They can be classed as economic values because individuals would be willing to allocate resources (spend money) to acquire them and/or protect them.

The economics field describes nonuse values as emanating from the public-good qualities of heritage—those qualities that are “nonrival” (consumption by one person does not preclude consumption by someone else) and “nonexcludable” (once the good/service is provided to anyone, others are not excluded from consuming it). A public archaeological site would exhibit these qualities very clearly. Markets fail to provide public goods and services, and nonuse values therefore pose a difficult methodological problem for economists.

In large part, nonuse values are an alternative way of looking at the sociocultural values described and distinguished above. Sociocultural values and nonuse values are two ways of slicing the same pie, as it were.

Nonuse values are often broken down into the following, closely related categories (which are not exhaustive) in order to specify exactly which qualities of heritage motivate economic decisions:

*Existence Value:* Individuals value a heritage item for its mere existence, even though they themselves may not experience it or “consume its services” directly.

*Option Value:* The option value of heritage refers to someone's wish to preserve the possibility (the option) that he or she might consume the heritage's services at some future time.

*Bequest Value:* Bequest value stems from the wish to bequeath a heritage asset to future generations.

## **Intrinsic Values**

How does the typology suggested here align with the “intrinsic value” arguments made regarding heritage—and also made vis-à-vis nature in environmental conservation? This typology is premised on the assumption that values are fundamentally contingent—in other words, that they are socially as well as spatially constructed. But can one assume that some of the values of heritage are intrinsic (if not fixed or absolute)—i.e., that some kind of historic value is intrinsic to the whole notion of something being identified as heritage?

This intrinsic-value argument in heritage conservation would be analogous to the “intrinsic” argument in environmental conservation, through which it is assumed that “natural” characteristics (wildness) are intrinsically valuable. This idea parallels the notion of authenticity in the heritage field, which presumes that some kind of historic value is represented by—inherent in—some truly old and thus authentic material (authentic in that it was witness to history and carries the authority of this witness). Thus, if one can prove authenticity of material, historical value is indelibly established.

---

## Methodological Issues and Strategies

It was asserted above that questions of value and valuing are not, for the most part, susceptible to technical solutions. Values are embedded in culture and social relations, which are ever in flux. Political realities—the patterns of power that join and separate the various stakeholders in the heritage—are ever present: they are sometimes on the surface of conservation activities; often they lurk just beneath. The practical goal in devising value-assessment methodologies, approaches, routines, and tools<sup>11</sup> is therefore not to search for the single best answer; nor is it to yield objectivity, technical precision, or a one-size-fits-all technique for effective conservation planning. Rather, the focus on methodologies (on the process of generating knowledge) will bring relevant information to bear, will lend transparency to the process, and will abet the goal of achieving wider, meaningful participation in the process.

This section of the paper airs a number of issues regarding methodological strategies for assessing heritage values and goes on to discuss a number of tools that are, or could be, used for assessment. In a survey of these available tools, one recurring theme is the conservation field's great potential for borrowing or adapting proven value-assessment methods from disciplines such as anthropology and economics.

Before describing specific methods and tools, some strategic issues underlying the choice of methods and tools should be rehearsed. This section highlights four such issues:

- some general issues and conditions surrounding the activity of value assessment;
- quantitative and qualitative methods for value assessment, and the fundamental epistemological and practical differences between them;
- the need for a “toolbox” methodological approach to heritage value assessment, one that flexibly combines a wide variety of assessment tools;
- identification of stakeholders and the widely recognized political issue of participation—in other words, the political and pragmatic imperative to give voice to experts, professionals, and other “insiders” to conservation, planning, and decision making, as well as to give voice to laypeople, local communities, and other “outsiders” to the process.

## General Issues and Conditions

Methodological choices for value assessment must, at some juncture in the management planning process, engage a few broad and fundamental issues (Figure 1).

First, the value assessment process actually consists of a few discrete but closely related parts. Value assessment is not a simple matter of simultaneous identification and measurement, like taking the temperature. Assessment can be broken down into three parts: identification, elicitation and elaboration (including exploring connections and overlaps), and ranking and prioritization.

Second, we can assume that no single value-assessment method will give perfect, total, or even adequate knowledge to inform conservation decisions on the ground. Given the varied nature of heritage values, knowledge about them is best gained by adopting a number of quite different perspectives (epistemologies) and, it follows, methodologies. To gauge sufficiently all heritage values of a project or site and to inform conservation decisions on the ground, a suite of varied methods—quantitative or qualitative, economic or anthropological—is likely to be the best course. A further challenge, addressed below, lies in matching appropriate methods to all the values identified in making a typology.

Third, context is one of the watchwords by which one can assure a varied, robust perspective on which values to assess. *Context*, as used here, refers to physical, geographical surroundings; to historical patterns and narratives; and to the social processes with discernible impact on heritage and its conservation. These include the cultural, social, economic, and other conditions contributing to significance, as well as the management setting and physical surroundings of the site. Heritage sites and objects must be understood in relation to their contexts—in other words, holistically. One cannot fully understand a site without understanding its contexts, which, perforce, extend beyond the site itself both literally and conceptually.

Conservation professionals have traditionally been very skilled in looking at certain contexts of heritage—relating to physical deterioration, environmental conditions, and other physical factors; or to art historical narratives and aesthetic canons—and have developed methodologies and tools for analyzing these contexts. But an understanding of heritage values in the fullest sense requires that conservation professionals cast a wider net and consider more and different contexts of

conservation—economic, cultural, and political. As a corollary to this, conservation professionals and planners must reach out to other fields and disciplines—which have already gained some experience in assessing such contextual issues—and bring more rigor to this engagement.

For instance, in approaching conservation planning for an archaeological site, it is often imperative to understand and deal with the pressures and opportunities presented by tourism development—not just the tourism activities that happen on the site but also the values that shape decisions well before and well after the actual visit. Such planning requires an understanding of economic forces, methods of economic analysis, public policy, cultural tensions, and trade-offs that often accompany tourism development, as well as the relationship of these factors to traditional conservation aims and principles. Moreover, the meaning of the archaeological site to the communities living around it may well be one of the driving forces behind the effort to plan and conserve. In this case, conservation professionals need to understand the values as seen by that community, which suggest a whole range of methodologies for articulating those values (ranging from ethnographic studies, to focus groups and interviews, to community involvement and “mapping” processes).

Fourth, several complications flow from the fact that values come from people—they are opinions. Values come into play only when they are articulated and championed by stakeholders. But whom does one consult or ask? How broad is the net of informants and spokespeople and experts? Where can one draw the line to limit the number of voices so that the diversity of values is representative and manageable and not overwhelming? There is no universal solution to this dilemma, but neither does one have only intuition to follow. These questions are addressed by constituency analysis and the ethnographic methods described below. Another complication relates to how one asks the questions—or, in the terms laid out above, how does one elicit values? As Theresa Satterfield’s research shows, asking for numerical responses and narrative responses to value-elicitation questions yields somewhat different sets of values (see Satterfield, “Numbness and Sensitivity in the Elicitation of Environmental Values,” herein; see also Satterfield, forthcoming). First, one should aim for a diversity of tools and forms of knowledge (not only numerical, not only narrative); second, one can seek out the kinds of values and stakeholders that usually prove most elusive—disadvantaged communities, spiritual values, a sense of place.

## Quantitative and Qualitative Methods

Economic and cultural modes of conceptualizing and gauging value represent two distinct and somewhat incommensurate ways of looking at value—one quantifiable and based on individual preferences, the other resistant to quantification and premised on collective meaning. In the main, economic values are best elicited and expressed by quantitative research methods. Mathematics is, after all, the fundamental language of modern economics. Conversely, cultural values submit to quantification only fitfully and inadequately. Qualitative research methods, ranging from narratives and analyses written by experts to interviews of ordinary citizens, elicit cultural values more effectively.

Grand claims have been made that economic methods based on neoclassical theory yield a comprehensive assessment of heritage values—these methods translate all types of value, it is said, into terms of dollars by simulating markets or assuming that markets exist for them. Such claims are fraught with problems, though. The best assessment of heritage values, many agree, comes from a complementary use of economic and cultural methods. (In his paper in this volume, David Throsby reaches this conclusion, arguing from the perspective of an economist thinking about the value of culture and the arts.)

Quantitative and qualitative methodologies derive from quite different epistemologies. Both provide ways of taking samples, making proxies of complex realities that cannot be described in toto. The two approaches can be seen as attempts to measure the same values, albeit from different perspectives, with different tools and discourses, and with different results. The information generated by both kinds of methods is disjunct—it is difficult, if not impossible, to measure and compare them on the same scale. Though they may be seen as competing paradigms, the information they generate is often complementary.

The particular strengths and weaknesses of quantitative and qualitative approaches need to be considered carefully. By their very nature, some kinds of values resist being compared or scaled—spiritual values, for instance—and thus are more susceptible to humanist, qualitative methods. The scalable results of quantitative methods are more easily cross-compared—thus, quantitative methods remain the lingua franca for policy makers. Quantitative methods focus on causal relationships and depend on variables isolated from their contexts. However, as mentioned

above, values and other forms of meaning are produced out of the interaction of artifacts and their contexts, not from the artifact itself. This arena is where qualitative research methods have a particular strength; they are sensitive to contextual relationships (as opposed to causal connections) and are therefore indispensable in studying the nature and interplay of heritage values.<sup>12</sup>

### A Toolbox Approach

Since a full assessment of heritage values will require a diverse suite of methods and a flexible approach, how does one begin to match methods to values? Can the values in the provisional typology be matched up with specific methods? Not in a hard-and-fast sense. The kinds of tools that have been brought up—expert analyses, quantitative/economic studies of use and nonuse values, ethnographic assessments—are by design quite broad in their sweep. **In each instance, the specifics of the method (the survey questions, the data collected, the experts consulted) would have to be designed, on a case-by-case basis, to respond to the range of values associated with the project and to the personnel available to manage them.** But it would, for instance, be sensible to imagine a planning process that used assessments with such components as economic impact analysis; surveys of tourists, including both narrative questions and quantifying methods such as a willingness-to-pay study; ethnographic studies centered on local communities (ethnic groups, indigenous people, recent migrants); interviews with local political officials and businesspeople; and thorough analyses of the historical, artistic, educational, and other values of the site from the scholarly/expert community.

The aim of the toolbox approach is to get all relevant heritage values on the table, building the fullest practicable account to inform policy making and decision making. The variety of values represented in the typology requires the use of a variety of tools in their assessment. To manage this variety of available tools in the planner's toolbox, the notion of triangulation is useful. Triangulation, which requires the use of a suite of different methods in complementary ways, should be at the core of an approach to eliciting and assessing heritage values.

**The underlying principle is that the layering of different, complementary pieces of information will produce a more accurate answer than would the pursuit of one or two pieces of information.**

Given their diversity, the elicitation of heritage values for a site requires casting this type of broad net by layering different approaches to yield the most robust results. In this vein, Denzin and Lincoln (1994) describe the contemporary social researcher as a bricoleur: one who patches together different methods to glean different sorts of knowledge, iteratively, opportunistically, to build the best composite answer to the question at hand. In the context of assessing the social impacts of environmental policies, William Freudenburg has suggested a somewhat more structured, **systematic version of the triangulation-bricoleur idea.** He outlines a three-part method: first, employing secondary research techniques using existing, archival data (both qualitative and quantitative); second, conducting primary research using ethnographic fieldwork techniques; and third, using “gaps and blinders” techniques (such as structured second-guessing, consultation, and public involvement) both to fill in the blanks of knowledge and to correct for the researchers' own biases (Freudenburg 1999).

**The goal of a flexible and useful methodology for value assessment has to be kept in the perspective of the larger goal of seeking more sustainable practices and policies for heritage conservation. It is a truism that the same approach will not work in all places, in all cultural contexts, for all kinds of heritage—it must be adaptable and variable.** With this flexibility in mind, the frameworks developed here aim to be meaningful for a range of stakeholders, take a broad view of values as motivations behind conservation, and accept wide participation as an inherent aspect of conservation. The methodological approach to value assessment proposed here must not only be flexible—the ideas and approaches should be transferable and useful. These are among the ingredients of more sustainable conservation.

It is significant that all of the experts contributing papers to this volume reach the same basic conclusion regarding future research: the formulation and testing of some kind of toolbox approach—well “integrated,” as Mourato and Mazzanti emphasize, across disciplinary lines as well as value types—is the next, urgent step to be taken.

## Stakeholders and Participation in Value Assessment

Having at one's disposal the most effective methods for eliciting and assessing heritage values is important. However, the real power of a values-based approach comes through using these tools to cultivate the values as felt, conceived, and realized by actual groups concerned with the stewardship of actual heritage sites. Engaging heritage values "on the ground"—so to speak—requires engagement with questions of influence, competition, power, and politics. One must venture questions such as: Who participates in heritage value assessment? Whose values are counted? Thus, who has power to shape conservation outcomes?

There are several different sources of heritage value: community and other culture groups, the market, the state, conservators, other experts, property owners, and ordinary citizens. In assessing values, the simplest political guideline is trying, as a matter of equity and accuracy, to work toward wide participation and account for the views of all the relevant valuers.<sup>3</sup>

The question of stakeholders is an essential issue in value assessment. The importance of stakeholders to the notion of values and value assessment is clear—stakeholders do the valuing. Thus, identifying the stakeholder groups and employing methods designed to reach and hear them in light of their particular character and capacity are required of any methodology for heritage value assessment. As it is widely believed that widening of the circle of stakeholders involved in a project improves both the process and the outcome, constituency analysis and identification of stakeholders is an extremely important task.

### INSIDERS AND OUTSIDERS

As shorthand for addressing calls for wider participation and stakeholder involvement in conservation, consider the gross distinction between insiders and outsiders to the conservation planning and decision-making process. The distinction stems from the notion that some stakeholders are "at the table" where values are identified, assessed, and ranked and where decisions are made, while other legitimate stakeholders are not present.

Insiders are those who can participate in the process by right or might—actors with power, such as public officials, bureaucrats, policy makers, those who influence them, and (to an extent) conservation professionals and other experts invited into the process.

Outsiders constitute everyone else with a stake in the heritage in question but with little or no leverage on the process. In some instances, outsiders are actively excluded from the process; in other instances, they have no knowledge of the process or lack fluency in the language of conservation and policy and perhaps even lack an inclination to participate. More and more frequently, efforts are made by both sides to shift outsiders to the inside. Outsiders can be brought into the decision-making process or else they can force themselves in—which happens often enough.

Outsiders are not simply nonprofessionals; conservation professionals, in fact, are often outsiders in that they have little access to making or shaping the most important decisions affecting a site. It must be noted that the values and interests of outsiders and insiders do not necessarily conflict (despite the opposition implied in these labels). Though they have a different relation to the decision-making processes, stakeholders on both sides might very well find common ground and benefit by the same course of conservation action.

The notion of including outsiders in conservation planning is fundamentally a political issue, a matter of power and authority. In one respect, such inclusion can be addressed formally by bringing outsiders into the client/steering group of a project, acknowledging outsiders' rights to property or use of a site, and so on. The politics of participation can also be addressed in choosing methodologies and designing the planning/management process. Choosing methods is not only a matter of choosing among different expert/academic discourses; it also embodies a political gesture as to whose analysis, voices, and values are included in the decision-making mix. Participation needs to be addressed at both levels: formal membership in the process and design of the process.

The outsider/insider distinction also highlights practical problems. While the values typologies discussed here might make sense to us as conservation professionals, what would be the value categories for outsiders? Would they be different? What kind of language and phrasing and communication would most effectively abet their participation? In devising and applying a typology for a project, these questions must be considered. By what methods can those conservation professionals, officials, decision makers, and other stakeholders at the table generate knowledge about the value assessments of those outside the process?

The insider/outsider idea may be useful for identifying participants in the present. But a third set of actors (constituencies) may also be brought into the process design—potential stakeholders. These could consist of groups who may in the future exercise some interest in the heritage site in question—future generations, for instance—or who may exist at a distance from the heritage site (literally or metaphorically) but take some interest in it (for example, the “community” of a nation’s citizens). These stakeholders, too, should be accounted for in value assessment.

#### ADDRESSING PARTICIPATION PRACTICALLY

But how can one address participation practically? Rhetorically, we all agree on the call for more participation. In principle, it is widely recognized that rigorous and meaningful participation needs to be seen as a valuable part of the planning process and integrated into many aspects of assessment and planning. But it will take real changes in professional attitudes as well as continual testing of new, context-appropriate methods. Professionals need to be open to other, nonexpert views about heritage values and decisions and embrace alternative ways of understanding value, negotiating differences, and so on.

The urban planning, environmental conservation, and development fields—and working with each, the discipline of anthropology—have wrestled with this issue a great deal, and a vast amount of practical and intellectual work has been done on participatory issues.<sup>14</sup> Such concerns have also made some inroads in heritage conservation. Progressive examples of participation in the heritage field include Australia’s Burra Charter process, the Main Street process pioneered in the United States, and numerous more local efforts being pursued, for instance, in Canada (Kerr 1999).

Insiders and outsiders have to get integrated not only in how their responses to value elicitation are expressed and recorded but at the level of how they frame questions of value. Therefore, insiders and outsiders should be included in the composition of project teams and through the planning process itself (in effect, becoming insiders instead of outsiders). The alternative to this kind of effective integration of insiders and outsiders—generating separate assessments of different types of stakeholders and simply collecting them—would fall short of a full assessment of a project’s heritage values.

In terms of the methods and planning process involved in this research, there are a couple of ways to address practically the issue of wider participation.

First, a thorough constituency analysis is needed to identify all stakeholders: inside and outside, near and distant, present and projecting into the future. This analysis should inform composition of a project team and a consultation process representing as many different relevant stakeholder positions as possible. The constituency analysis should also be revisited periodically throughout the project, as new or different groups may come to light. A second measure for ensuring participation is the kind of ethnographic-economic suite of methodologies suggested throughout, the basic purpose of which is to engage many stakeholders in the assessment of heritage values driving conservation planning and management, engaging them with elicitation tools congruent with their “fluencies” and the values they tend to hold dear.

---

### Tools for Eliciting Heritage Values

How can the views of the many parties with a stake in a heritage site be searched out, articulated, and brought to the table?

This section concerns the tools used in the “elicitation/elaboration” part of the value assessment process (see Figure 2). At this stage, where the values have already been identified and a typology for the site has been created, the methodological issue is choosing tools appropriate to elicit and characterize (elaborate upon) the different heritage values. Several kinds of tools are detailed below; they include, for instance, economic impact studies, contingent valuation studies, ethnographic studies of particular culture groups, historic contexts written by historians, or scholarly analysis of artistic merits. As noted previously, certain methodologies are better suited to gauging particular values.<sup>15</sup> There are no hard-and-fast rules to guide the choice of tools, only rules of thumb.

### Tools Suited to Cultural Values

A wide range of methodologies is used in a large number of fields relevant to matters of heritage conservation. Which kinds of methods are best suited to gauging cultural values in a broad, comprehensive (though not necessarily exhaustive) way? We make several assumptions from the start: that gauging cultural values adequately will require a suite of different methods; that this suite will likely include both quantitative and qualitative methods; that one of the goals of the suite approach is inclusiveness; that this suite will have to be adjusted as it is applied from project to project.

The conservation field has traditionally relied on expert appraisals (of artworks, buildings, and other objects, by art historians, architects, and archaeologists) for guidance on what to conserve. And the field has traditionally relied on scientific and documentary methods to analyze the physical conditions of heritage and to determine how to conserve.<sup>16</sup> Expert appraisals from a number of different disciplinary perspectives will continue to be an important input to value assessment, though they have already started to be combined and integrated with other kinds of assessments (detailed below), attuned to capturing the values of other stakeholders.

Art historical canons of taste, beauty, innovation, and authenticity—along with age or perception of age—have traditionally been an important source of valuing for the conservation field. The works of Reigl, Ruskin, and other nineteenth- and early-twentieth-century art historians and critics are foundations of these methods of valuing heritage, which were marshaled by art historians and by collectors themselves. These experts fixed the value of things, and then conservators fixed those things materially. The values themselves and conservation decisions stemmed from judgments made by a connoisseur and/or scholarly expert trained in the canons of taste, authenticity, and historical significance.

The work of Cesare Brandi and Paul Philippot—and, before them, Boito and Giovannoni and others—underscored the need for conservation professionals to understand the object within its broader context and thereby helped advance the notion of conservation as an interdisciplinary, technical, and humanities-based discipline, well beyond its craft origins.<sup>17</sup> As a maturing discipline, conservation method has involved the development of standard approaches to the documentation and analysis of art/architectural histories, formal and material compositions, and physical conditions. These tools and methodologies have provided additional insight into assessing values, in that they inform understanding of the evolution of and use of objects and places, identify original elements and materials, help interpret artists'/creators' "original intent," and relate changes to intrinsic factors (design, material composition, and so on) and to extrinsic factors (environment, human intervention or lack thereof, and so on).

But this notion of context was narrowly drawn—pegged to some physical contact with the heritage itself. The values beyond those apparent from visual-textual-iconographic-material analysis by conservation experts and connoisseurs have been explored minimally. However,

we need a more social conception of context to get at the values that go beyond the site itself but that affect the site—for example, cultural change, economic markets, the dynamics of civil society, the politics of nationalism and ethnic conflict, and so on.

Other fields related to conservation (rural development, ecological conservation) have more avidly sought to understand contextual issues and to bring them into the analytical territory familiar to practitioners. A wide range of qualitative methodological approaches is used in humanities and social science disciplines and professional fields (especially urban planning, the development field,<sup>18</sup> and environmental conservation) to study social phenomena. Most methods are rooted in a certain discipline—for instance, ethnography with anthropology, archival research with history, mapping with geography—but the spread of interdisciplinary research and a broadly held, catholic attitude toward the use and mixing of qualitative methods make it somewhat misleading to identify certain methods with only their originating disciplines. The main direction in the social sciences and humanities has been "pollination" across disciplines.

The following general methodologies are offered as a spectrum of basic approaches, not specific to any one arena but, rather, applied in anthropology, archaeology, geography, sociology, city planning/urbanism, and various hybrid fields.<sup>19</sup> Each one is newly used in heritage value assessment and has potential use for assessing values in conservation planning.

#### EXPERT ANALYSIS (TEXTUAL/ICONOGRAPHIC/FORMAL/SEMIOLGIC)

Detailed analysis of particular objects, things, symbols, and texts is the stock-in-trade of experts in any academic or professional field. As noted above, in the conservation field, this type of analysis has historically been exemplified by the connoisseurship judgments of art historians, curators, and collectors.

An expert interprets values and other phenomena through theoretical screens (tacitly making a great many epistemological assumptions) and interprets how they are embedded in their wider contexts. Often the outcome is some appraisal of the value of the object or phenomenon according to a scale of values internal to the profession. Such disciplinary distinctions purposely tend to isolate the judgments of these experts from other inputs (if expert knowledge is not set off from others' knowledge, it loses its value), so they work against the goal of wider participation. Who are these experts? They are the professionals

trained in nearly any humanistic or professional field: historians, art historians, architects, anthropologists, geographers, and so on. Since these analyses are inherently the province of experts—analyses are de facto valuable if they are done by experts—there are few opportunities to compare or verify the judgments made.

#### ETHNOGRAPHY

Ethnography includes methods of describing and recording the characteristics of a culture. Ethnography is usually, though not necessarily, qualitative. It relies on information-gathering activities such as interviews, oral histories, observation, and recording of the characteristics of material culture. With a number of particular information-gathering tools at hand, ethnography seems well suited as an approach to eliciting heritage values.

Initially seen as a positivist methodology, ethnography has come to focus on recognizing the subjectivity of the observer as well as on recording the characteristics of the culture that is the object. Many ethnographic approaches have been developed in the field of anthropology, from participant observation studies of exotic cultures early in the twentieth century to “thick description” (emphasizing the embeddedness of cultural practices/features in their myriad contexts, knowledge of which is built up by thick description) to today’s very value-sensitive approaches to representing the many voices contributing to culture.

These types of applied social anthropology are of particular interest to heritage conservation. Indeed, some anthropologists and designers have jointly employed ethnographic methods as part of land- and community-planning projects, synthesizing information about social and physical contexts and using this information to generate design and planning solutions. Setha Low’s paper in this volume describes the specific ethnographic approach she and her colleagues have used in studying and planning heritage projects.

The tools Low and others have employed include interviews, focus groups, mapping exercises, and structured observation techniques (Low 1981; McHarg 1992). These eclectic but structured ethnographic methods have been adapted to heritage conservation as the rapid ethnographic assessment procedure (REAP), a planning method developed with the U.S. National Park Service.<sup>20</sup>

Likewise, an applied ethnographic methodology called participatory rural assessment (PRA) is often used in the public health and development fields (particularly in agricultural development efforts in less-developed

countries). PRA consists of a flexible menu of ethnographic and public-involvement techniques aimed at understanding the values and knowledge that local populations—traditional cultures and nonliterate groups in particular—wish to sustain as they encounter Western, nongovernmental organization efforts to modernize and develop their economies. PRA not only aims to glean knowledge about the values and skills of non-experts and the unempowered, it also aims directly to empower them.<sup>21</sup>

#### *Surveys and Interviews*

As mentioned above, ethnographic methodologies often employ interviews and surveys as data collection tools. Surveys are used in myriad fields, from market research in the business world to those done to collect data for sociological studies. They can be designed and conducted in a great many ways (to elicit simple data or complex responses, gathered in person, on paper, by telephone, and so on). Interviews, too, can be designed in a variety of ways—structured or unstructured, using graphic or written or recorded responses. Interviews can be undertaken strategically, focusing on a few key informants, or extensively, with samples of hundreds. An enormous literature of applied work exists on these tools.

#### *Other Participatory Methods*

The field of planning/urbanism is another source of methods for engaging multiple stakeholders in planning and management efforts. Since the 1960s, many methods have been applied in many kinds of projects. Dealing with decisions on urban, social, environmental, infrastructural, and economic development issues, planners have employed varied means for understanding how ordinary citizens ascribe value and how this affects development decisions. Methods often include surveys, public meetings, focus groups, and key-informant interviews; visioning, Delphi, and other group processes; mediation and conflict resolution, in cases where a clear dispute has arisen; institutionalizing the involvement of existing community groups; and even the creation of new community groups (or capacity building among existing groups).

#### MAPPING

Plotting data on a map or plan is one simple and distinctive way of organizing information. Mapping can be exceedingly simple or very complex. It is so broad and basic a way of handling data that it is perhaps a stretch to call it a methodology; but in the broad definition being used here, it does constitute a way of generating knowledge.



Mapping is already a basic methodology in conservation, as part of the assessment of the physical conditions of the heritage being studied. Conservation professionals, architectural and landscape designers, and planners routinely use mapping and mapped information (existing conditions) as the most basic methodology for approaching any project.<sup>22</sup> The analytical potential of mapping techniques has been made more powerful by the introduction and wide use of desktop geographic information systems (GIS) and the digital databases linked to them. GIS systems are not in themselves a method of value elicitation; they are a tool for organizing and analyzing data in the service of planning and management.

Another distinctive kind of mapping methodology is interactive mapping, when the choice and recording of information on a map is not managed by professionals, experts, or decision makers but, rather, by community members or other nonprofessionals. Examples of interactive mapping include “mental mapping,” done as a kind of survey; community-generated maps (such as the “parish map” process pioneered by the English group Common Ground, which stimulates communities to represent the identity of their place in innovative ways); and the informal rocks-and-dirt “maps” included in some PRA models.<sup>23</sup>

#### PRIMARY (ARCHIVAL) RESEARCH AND WRITING HISTORICAL NARRATIVES

The basic humanistic methodology of research, interpretation, and writing a narrative account remains one of the most effective to construct and express knowledge about values. Constructing a story, based on primary and other research, is a particular way of documenting and describing social phenomena. Narratives deal with causation in a more circumspect way than, for instance, do statistical methods. Often the contexts and settings of a phenomenon are bundled into stories alongside human actors and institutions. Understanding is gained by the unfolding of a story through characters and influences, not, by contrast, through abstracting relationships among isolated variables.

In the last few decades, the work of social historians has gained more and more influence in the heritage field. Historians’ work speaks most directly to the associational (often termed historical) values that are a major motivation behind conservation.

#### SECONDARY LITERATURE SEARCH

Secondary literature research perhaps goes without saying, but it should not be overlooked as an expedient, strategic methodology for quickly generating information relevant to a project. It has become especially time effective, given the widening availability of online bibliographic and information-search resources.

#### DESCRIPTIVE STATISTICS

This simplest of quantitative methods is widely used by the whole range of qualitative disciplines, signaling the virtual impossibility of really separating qualitative and quantitative epistemologies. One application of the simplest kind of descriptive statistics is content analysis (of, say, media coverage or interviews: how many times was aesthetic value mentioned versus economic value?). More commonly, demographic analysis is used to characterize a population in shorthand. Tabular data are gathered in tables and sometimes mapped or presented graphically, giving an effective, though often quite cursory, account of the current state of a population. (Multivariate statistics are also used widely by social scientists, to understand and theorize relations among different phenomena. As noted in the earlier discussion of quantitative and qualitative methods, multivariate statistics is scientific in the sense that it attempts to isolate variables and find causal relationships, whereas descriptive statistics aims to build more simple contextual understanding.)

#### Tools Suited to Economic Values

The various tools devised by economists<sup>24</sup> to assess the values of cultural heritage are adapted from those devised earlier to measure the value of environmental resources as part of environmental conservation decisions. Earlier work by the Getty Conservation Institute and the growing cadre of cultural economists has summarized and evaluated these contributions to heritage valuation. Mourato and Mazzanti, in the present volume, provide an excellent summary of this past and present work in the cultural economics of heritage, and their own work is clearly on the cutting edge of economic thinking about heritage values (see also Mason 1999; Hutter and Rizzo 1997). In light of Mourato and Mazzanti’s contribution to this volume, a very brief summary of economic tools for value assessment will do.

### REVEALED-PREFERENCE METHODS

Revealed-preference methods draw and analyze data from existing markets for heritage-related goods and services.

*Economic impact studies* have become very popular because of the use of a quite simple method, and they often suggest clearly that investment in a heritage project will yield tangible economic gains. By measuring economic investments and employment gains directly related to conservation activity, and multiplying this on the theory that these direct investments yield secondary gains as they ripple throughout the economy, impact studies identify exact returns on investment (which is to say, increases in the value of the heritage). Impact studies may be useful in identifying some use values and some externalities of heritage investments, but they are often suspect because of double counting and because they fail to account for the opportunity costs of heritage investment.

*Hedonic pricing methods* can measure nonuse heritage values only as they are reflected in related market transactions. They measure the increments in financial value gained, for instance, from the proximity of a real estate parcel to a particular heritage resource.

*Travel-cost methods* measure heritage values through the proxy of travel expenditures related to the use/consumption of heritage sites or objects. By only recording values when they are translated into individual decisions to travel, these methods give highly partial accounts of heritage values.

### STATED-PREFERENCE METHODS

Stated-preference methods rely on the creation of hypothetical markets in which survey respondents are asked to make hypothetical choices, which are then analyzed as value judgments.

*Contingent valuation methods* measure total value ascribed to a heritage site by an individual (expressed as willingness to pay for it) but do not break down the value, leaving it undifferentiated. The method draws information from individual appraisals and decisions, in hypothetical markets, and does not see the collective picture at all, except by aggregation and inference. This method is beginning to be used more extensively for heritage projects, because it yields the sought-after conversion of qualitative values into quantified prices. (In the case of heritage, the corresponding concept of willingness to accept compensation for loss of a resource can also be relevant.) It should be noted that the insights and conclusions drawn from contingent valuation studies of heritage resources have been limited to instances where they are carried out under very stringent conditions.

*Choice modeling* is a potentially very interesting method for heritage in that it does break down the specific attributes of the overall value expressed by study participants. Therefore, it could be used to measure the values (the utility to individuals) associated with the different characteristics of a heritage site, according, for instance, to the typology outlined above. Though people do respond well to these types of scenarios and comparisons, the method presumes very well informed participants, and it will not capture well the intangible, difficult-to-price values (such as spiritual values).

Economic methods in general have gained a great deal of credibility by (1) presenting data in a seemingly objective form (prices), and (2) appealing quite directly to the business-thinking mentality of global decision makers and, increasingly, of society at large. Economic methods are used more widely and for new purposes, and they are gaining credibility. But there remains a great danger in relying on quantitative economic methods alone—this is a view strongly endorsed by some economists, including some of those involved in GCI's research. The neoclassical economic model is so well refined, so tightly theorized to block out uncertainties, that it sets a tone in which other values seem a priori excluded (or devalued). This situation is problematic in several respects, among them that people cannot talk about certain kinds of value in monetary terms; cognitively, quantitative language doesn't work very well, for instance, to express spiritual values. In other situations, the ability to express a commonly held qualitative value in quantitative terms has been critical to getting proconservation decisions made, so the urge to quantify remains very strong.

All the methods described in this section need professional economists to direct them; there are many technical problems to be dealt with, and the methods can easily be abused if applied in an uninformed manner. But the stated-preference methods, which include extensive survey processes, open up a lot of common ground (and potential collaboration) with the approaches used by anthropologists and other social researchers. The ways that economists create and adjust survey instruments are basically identical to the ways that anthropologists do it (an iterative process of piloting, refining, rolling out).

## Matching Tools to Values

In the transition from a typology of values to their assessment, **there should be a deliberate effort to match assessment tools to values.** The choice of tools affects values—some tools give a more accurate or detailed view of certain values than others. For instance, economic impact studies foreground the economic use values stemming from decisions of tourists but don't directly address all the sociocultural values of a site. This circumstance is analogous, one could say, to chemistry analytics: in a given situation, some compounds are best detected by gas chromatography, others by mass spectrometry.

**There is no set recipe or methodology for matching values with tools.** What follows is the author's suggestion of how an iterative process of trial and error, along with triangulation with a variety of methods, would constitute a useful approach to matching tools to values.

As a first step, one tool specially suited to gauging each type of value identified (e.g., historical, artistic, spiritual, use) should be sought. At the minimum, there should be a broad tool suited to economic values and a broad tool suited to cultural values. There should be a tool focused on experts' input, as well as a tool focused on public, layperson perspectives. A particular tool can be used to gauge more than one kind of value (for instance, an ethnographic assessment could be designed to assess spiritual as well as social values). Here are some more general guidelines:

- Make sure the diversity of tools, and the “fluencies” they represent, match the diversity of values that have been identified.
- Choose experts and professionals with an eye toward their capacity to understand and accept the methodologies of others.
- Complement qualitative and quantitative tools.
- Make the process of assessment iterative, to the extent allowed by budget and resources; start broadly, then adjust to more specific tools.
- Attempt to give voice to outsiders as well as insiders.

---

## Integrating Assessments and Frameworks for Decision Making

Once the broad array of values linked to a site are assessed, how does one go forward? How does one connect these assessments with the difficult, politicized work of prioritization and decision making? (In reference once again to Figure 1, how might one connect the “assessments and analysis” phase of management planning with the “response” phase?) As with most issues regarding planning processes, there is no prescription, but this section outlines a series of steps—necessarily conceptual, until they are developed in relation to particular projects—for building on the value assessments to tackle decision-making tasks. These steps must realistically involve some integration and even prioritization of the values assessed. Suggesting how this can be done—without prescribing it—is the goal of this section.

The second part of this section describes (in broad terms) how sustainability principles could be adapted to provide some frameworks for making and evaluating management planning decisions both within projects and across multiple sites.

The steps are described conceptually, not as a rote set of tasks and not to the level of detail that would perforce arise from actually adapting and executing them. While specifying the steps in great detail would need to be done in the case of a specific site, project, and team, that process is beyond the scope of this paper. (Thus, to take this research further requires some application, testing, and fine tuning of these suggested steps.)

### Integrating Value Assessments

Four steps are suggested for integrating value assessments and implementing as part of the planning process: creating statements of significance, matching values to physical resources and site characteristics, analyzing threats and opportunities, and making policies and taking actions. The steps, which are discussed below, are not to be undertaken in a linear fashion—indeed, some of them can and should be done in parallel (see Figures 1 and 2).

#### **CREATING STATEMENTS OF SIGNIFICANCE**

Statements of significance flow directly out of the value assessments. Their function is synthesizing the reasons behind all the actions one might propose for the site—conservation, development, interpretation, and so on—and providing clear positions that would form the basis

of later decisions and evaluation. Generating a statement of significance is standard practice in conservation planning in, for instance, the United States. The professional team looks at all the varied values and assessments, culls and winnows from these the dimensions of significance and meaning, and articulates significance in terms that will be understandable to all stakeholders (and indeed, they should be understandable to the general public, to decision makers, investors, and so on).

The statements proposed here depart from the convention by emphasizing the plural, and perhaps even contradictory, nature of a site's significance. The statements do not necessarily have to be boiled down to one or two points, nor do they need to reflect a single consensus or universal view about the site. In fact, one would expect conflicting statements of significance to be articulated for a site (for instance, one set of stakeholders may see significance overwhelmingly in terms of profit, while other stakeholders' significance would exclude the possibility of profit-making activity.) Thus, the plural *statements* is emphasized, and it signals the intent of this step to identify the main themes of significance arising from the value assessments, as interpreted from the perspectives of the various stakeholder groups involved.

The creation of statements involves two distinct parts. **First** is the cataloguing and articulating of all aspects of site significance. In this sense the statements are unabashedly plural. These would be framed by the overall set of values and stakeholders identified earlier in the process. It is important to stay away from statements that privilege some values over others—that is, if one decides early on that value A is less important than values B and C, the tendency in case of conflict would be to sacrifice A for the sake of B and C; if the values are not ranked, more efforts are likely to be made to find policies that respect them all. **Second**, one can begin to introduce some sense of priorities by assessing and stating the uniqueness or importance of the site's values vis-à-vis other sites in the nation/region/world (whatever the decision-making domain is).

This recognition and articulation of the relative importance to the values—without ranking categorically their importance for the site—is borrowed from Pearson and Sullivan (1995) and from Kerr (2000). They suggest at this point an assessment of the degree or level of significance of each value, as seen against the universe of site

and values in the decision-making domain. This is not where one would say that the historical value of the site is more important than its recreational value. Rather, what is suggested is an evaluation of the degree of importance of a particular value (unique, important, typical, etc.) of a site when compared with that value in related sites.

#### MATCHING VALUES TO PHYSICAL RESOURCES AND SITE CHARACTERISTICS

Management, plans, and decisions must integrate articulations of value and the physical properties and resources of the site. This integration has traditionally been part of the analysis contributed tacitly by conservation professionals, but the correspondences between values and the physical attributes of heritage need to be made explicit. Without consciously evaluating the connections between specific physical aspects of heritage and specific values, as well as the appropriateness of the tools chosen to the values present, it will be difficult to predict or monitor how values are affected by material interventions or management decisions.

Therefore, some sort of mapping of the values invested in specific site elements and characteristics is an important reference both for informing decisions and for evaluating their results. In GCI's model planning process (Figure 1), this matching occurs at the end of the assessment phase, in which assessment of physical conditions is linked with the assessment of significance. How this is achieved practically and in detail can be worked out in any number of ways, in light of a specific planning project. At the least, all types of value identified in the values assessments should be "mapped" onto the site; all the main physical elements of the site could be linked with specific types of value.

The benefits of this step would be twofold: first, simply, a clear delineation of how each of the values identified for the site is expressed, embodied, or otherwise represented in the materials of the site (ranging in scale from artifacts to buildings to landscapes); second, key "complexes" of (material) resources and (immaterial) values could be identified. By identifying these complexes, the planning/management team is deliberately associating the values held with regard to the site to the actual physical resources making up the site. For instance, the key historical value complex for a historic building might associate the site's most important historical events, narratives, and concepts with the arrangement of buildings on the site or with the decoration of particular rooms or with

landscape elements such as walls or hedgerows. The most important complexes will likely be the focus of conservation and management interventions.

#### ANALYZING THREATS AND OPPORTUNITIES

Against the background of the statements of significance and their association with particular material aspects of the site, the analysis should turn to the potential threats to the identified complexes of material and significance. Threats can be quite varied and could be categorized, for instance, according to the following categories: physical threats stemming from environmental factors, from vandalism or violence, from neglect or poor management, or from economically driven redevelopment; and social, cultural, or political forces that produce changes in meaning and valuing. Conservation planners should not be looking only for threats, however. The opportunities encountered at sites should also be brought into this analysis, as decisions to take advantage of opportunities (whether economic, political, interpretive, logistical) are very likely to have an impact on the value-material complexes—sometimes positive, sometimes negative.

The professional team, by this juncture, should be able to identify the threats. The threats, of course, can only be defined against the context of the conservation/management goals of the stakeholder groups governing/influencing the site. One stakeholder's threat may be another's opportunity.

#### MAKING POLICIES AND TAKING ACTIONS

At this point, the planning process has moved on to the "response" section of Figure 1. Here the actions needed involve not so much integrating values but, rather, acting upon them. The specific steps by which these actions are worked out and implemented will vary widely from site to site, depending more than anything on institutional setup, organizational cultures, and other issues raised in the management context assessment.

In light of the plural, varied, often conflicting nature of heritage values and in light of the political processes inescapably shaping and usually governing decisions about conservation, are there any generalizations that can be made about conservation decision making? It is argued here that there are some robust principles useful for framing decision making in any number of circumstances. These suggestions take up the next and final section.

## Assessing Management Context

Well before the integration steps outlined in this section, an assessment of the management context needs to be undertaken. This is best undertaken at least as early as the physical conditions and values assessments are begun, and perhaps earlier (see Figure 1).

*Management context* refers to a number of factors that affect the capacity of people and organizations to decide, direct, and implement any plans that are formulated. This includes pragmatic concerns such as financing, institutional architectures, legal and regulatory frameworks, and available personnel, as well as political factors such as the patterns of power and influence known to shape the interactions and capacities of the various stakeholders in the site. The issues arising in the management context—especially those of power relationships—are crucial to the ultimate success of management planning and must be dealt with as systematically and as openly as possible.

The management context assessment through which these factors are documented and analyzed has not been studied in detail, though some version of it is part of most management planning processes. The review—and possibly the adaptation—of some of the methods for management assessment used in the fields of urban planning and business management can provide a starting point for the conservation field.

## Frameworks for Decision Making

A number of decision-making processes and protocols are available and widely used in other fields, but none of them are a priori appropriate to heritage conservation or robust across all situations. Therefore, no specific decision-making tools are advocated here. However, this paper does suggest frameworks for decision making, establishing a series of guides useful for assembling information to fuel decision making and frameworks for evaluating decisions afterward.

While there are no prescriptions or recipes for heritage conservation decision making, guidance for planning/ management decisions (ranking, prioritizing) can be drawn from other fields—in particular, environmental conservation. Research, application, and evaluation of decision making have been the subject of considerable work in the environmental sphere, and much of this is quite relevant to heritage conservation decisions. **The concept of sustainability, in particular, has been an effective and influential organizing principle in environmental decision making.** Although full sustainability remains an ideal, sustainability principles have, in practice, been merged with extensive experiences in cultivating public participation. The result is a growing body of practical lessons drawn from the use of sustainability principles.

The use of sustainability principles for guiding such complex decisions is the state of the art in the environmental conservation field. There are many parallels between heritage planning/ management decisions and environmental decisions: comparable complexities in the systems and processes being managed, diversity and incommensurability of values attributed to the resources being conserved, and political difficulties and power differences among stakeholders, to name a few.

A recent publication by several scholars and practitioners in the environmental field provides a good source of intelligence for addressing the decision-making challenges set forth in this paper (Sexton et al. 1999). Having identified critical issues and cases in environmental decision making, Sexton and colleagues evaluated state-of-the-art decision-making tools. The conclusion reached was that there are no hard-and-fast rules or procedures for making effective decisions. The goal of fostering integrated decision making requires a lot of experimentation and improvisation. The authors offered the following guidelines, derived from twenty or so years of experience with decision-making strategies in the environmental conservation field (Sexton et al. 1999, 447–58):

- build mutual trust and understanding;
- adopt sustainability as a unifying principle;
- take shared responsibility;
- institutionalize public participation;
- continually refine and use decision-making tools;
- collect and analyze important information (gather data for evaluation);
- use incentives to encourage innovation.

For the most part, the advice represented in these points is not specific to environmental issues and resources and is readily applicable to any other field. In order to retool and reorient this research for the heritage conservation field, though, the notion of sustainability needs to be rethought in terms applicable to heritage. The following section considers the second of these guidelines and discusses how sustainability principles for heritage conservation might be approached.

### SUSTAINABILITY PRINCIPLES FOR HERITAGE CONSERVATION

Principles of sustainable development have proven quite useful, influential, and robust, not only in environmental conservation and the fostering of ecological sensitivity in the development field but also, increasingly, in the urban development field. Sustainability has already been proposed as an ideal and as a guide to policy in the heritage field (English Heritage 1997; US/ICOMOS 2000). David Throsby has proposed a set of sustainability principles that could form the basis of a useful set of guidelines and norms for decision making in the conservation-planning model (see Throsby, “Cultural Capital and Sustainability Concepts in the Economics of Cultural Heritage,” herein).<sup>25</sup> The principles are built on the notion of sustainability developed in the fields of ecological conservation and economic development and adapted in light of Throsby’s notion of cultural capital (heritage resources) as analogous to natural capital.<sup>26</sup>

The notion of sustainability accords with the principles underlying values-based conservation planning in that it adopts a holistic view of resources (in this case, cultural resources) and their contexts and aligns with the goal of taking account of the widest range of heritage values. It deals directly with the problem of making decisions in the present but for the very long term—essential for acknowledging the role of heritage as an inheritance to be stewarded and passed on to future generations. Sustainability has also proven to be politically resonant (even after twenty or so years) and practically useful because the principles are a flexible frame of reference rather than a fixed

benchmark or rigid method (and, not surprisingly, sustainability has been criticized for the same reason by those who wish for inflexible environmental standards).

Ideally, the sustainability principles will influence the planning model in several ways, at several stages. First, they constitute an ideal, which could shape the setting of project goals, the composition of the stakeholder group, the analysis of significance and management contexts, and the evaluation of project outcomes. The principles will have most direct impact, however, at the policy-setting stage: the principles would be designed to serve as tests, or criteria, against which the policies (and thus the actions that follow from them) can be judged. Individually and as a group it can be asked, Do these policies meet the tests of sustainability? Each decision can be evaluated (informally, or with formal indicators) against each of the principles. The same tests can be applied to the actions as they are being formulated. In this way, the sustainability principles play the role of guidelines.

The fact that sustainability principles are a flexible, negotiable set of standards could be seen as a weakness. In the environmental field, a distinction is made between “strong” versus “weak” sustainability in the environmental sphere. Strong sustainability insists on immediate and total conformance to sustainability principles and is not negotiable—so it is generally seen as infeasible (and therefore unsustainable!). Weak sustainability allows change, is flexible, and doesn’t attempt to freeze things in place. These two versions of sustainability parallel the notion of distinguishing “sacred” versus “tradable” heritage<sup>27</sup> and the a priori privileging of cultural values over economic values by preservationists (or vice versa by investors or policy makers). Whereas it is easy to insist on the total protection of things deemed sacred, in light of practical considerations, this is not possible and becomes mere rhetoric. A more pragmatic strategy recognizes the need for trade-offs and recognizes that some heritage is in fact tradable or convertible to other forms of capital.

Sustainability principles also recognize the moral aspect of sustainability, through principles regarding intergenerational and intragenerational equity, which overarch and strengthen the scientific, economic, and pragmatic arguments for sustainability. The notion of equity, which requires moral vision and ethical reflection, should be closely allied with our collective sense of professional ethics and purpose. These ideas could, indeed, provide the conservation field with something of an ethical-moral compass as it navigates through a period of great change.

So as we see, sustainability holds great potential as a framing concept for the task of integrating heritage values, yet the concept needs to be developed further and applied to specific projects. As in the environmental and development applications of sustainability, sustainability indicators could be created to bring rigor and clarity to the application of sustainability principles.<sup>28</sup>

Additional work is needed to make the argument for using these sustainability principles and to describe how they can be used in real situations. For instance, how are the various sustainability criteria/ tests weighted? Are they all equally important in a particular project? Also, what exactly is being sustained—cultural resources themselves (buildings, artifacts, sites) or cultural memory and meaning? Answers to these questions can help connect the sustainability principles with the issues of heritage values and valuing.

Finally, decisions need to be continually evaluated and checked against the original aims set out at the beginning of the process. This continuous revisiting of the effectiveness of decisions is a key ingredient to the successful implementation of planning measures and to the realization of effective management for heritage conservation.

---

## Notes

1. The Burra Charter gives a central role to cultural significance (Marquis-Kyle and Walker 1992). See Tainter and Lucas (1983) for a critical history and analysis of the significance concept, and Tomlan (1998) for a collection of views appraising and criticizing the significance concept in the context of historic preservation in the United States.
2. The operational, applied context of this research is the model process for conservation planning used by the Getty Conservation Institute (see Figure 1). This model, which is similar to others employed around the world by conservation agencies and professionals, draws on a collective body of knowledge and experience accumulated over decades of application.
3. “Value-based management” is the coordinated and structured operation of a heritage site with the primary purpose of protecting the significance of the place as defined by government authorities or other owners, experts, and other citizens or groups with a legitimate interest in the place.
4. A note on terminology: *methodologies* refers to strategies for assessing heritage values; examples of two different methodologies would be ethnographic research and cost-benefit analysis. The term *tools*, as used here, refers to specific research protocols to implement a methodological

approach; examples of tools would be oral history, expert iconographical analysis, or contingent valuation analysis.

5. These definitions parallel the distinction made in the field of environmental conservation between “held” values (the principles or ideologies that guide environmental professionals and advocates in their work or that constitute the “cause” of environmentalism) and “assigned” values (assigned by people and groups to the natural resources themselves).
6. Typologies of the values of natural resources provide an interesting analogue to these heritage value typologies. See Kellert (1996) and Rolston (1988), as well as Satterfield’s paper in this volume.
7. A third major category of values could well be added to this framework—that of ecological values. Ecological value, as defined here, stems from the role a heritage site may play in constituting or sustaining a natural ecosystem—as, for instance, in shaping the flow of water or other natural resources or in maintaining species habitat. An archaeological site could be part of a highly valued coastal environment or watershed. As such, these ecological values could fall into both sociocultural and economic value categories—but they relate to different sets of stakeholders. Because these values and stakeholders can play a significant role in decisions about a site, ecological values may in some instances warrant classification as a separate category of heritage value. A deeper exploration of the ecological values of heritage sites is beyond the scope of this paper’s argument.
8. Similar breakdowns have been made in Frey (1997), Throsby (2001), and a World Bank report (Serageldin and Steer 1994).
9. Externalities are a third important kind of economic value; they are a spin-off of the other types of economic values. Externalities are consequences of transactions and other decisions regarding use and nonuse values, and they are generated for better (positive externalities) and for worse (negative externalities). In the sense of heritage values, externality values result from transactions involving the use and nonuse values of heritage as described above. Examples are the travel costs associated with visiting a heritage site or the increased price of land adjacent to a conserved site. For more background and detail, see the papers by Mourato and Mazzanti and by Throsby in this volume.
10. The terms *market* and *nonmarket* are used here as synonyms for *use* and *nonuse*. I believe that this association makes these categories more understandable and accepted among noneconomists, and it follows directly from the clear description David Throsby gives in his paper herein.
11. See n. 4.
12. Another important distinction between types of humanities and social science methodologies is that of positivist or phenomenological (and, more recently, “postpositivist”). The positivist/postpositivist distinction is different from the quantitative-qualitative question but is not unrelated to it—quantitative or qualitative methods can be either positivist or postpositivist—and it sheds particular light on the issue of methods for gauging heritage values. Positivist methods assume a value-free, objective perspective. They exchange scientific certainty for value sensitivity. Phenomenological or postpositivist methods, by contrast, embrace the values and politics surrounding any epistemological effort. By embracing value differences and representing the contexts of phenomena being studied, postpositivist methods should be part of any approach to assessing heritage values. This is not to say that positivist methods have nothing to contribute to heritage value assessment, but one can say that a strictly positivist assessment would yield a decidedly partial account of the range of heritage values. See Denzin and Lincoln (1994) and Frankfort-Nachmias and Nachmias (1996).
13. The political consensus is for broader participation. Note that this consensus is driven by a Western notion of democracy and will not be accepted or relevant in some cultural contexts. The position adopted here is to advocate broader participation without imposing it.
14. See, for instance, the strong base of research and application reflected in Sanoff (2000).
15. For instance, unstructured, one-on-one interviews might be best suited to eliciting the spiritual values of a site; the economic use values of the same site would be more susceptible to an economic impact study of tourist expenditures.
16. More recently, conservation decision makers have also turned to economic analysis and anthropological/community-involvement tools to strengthen the information base for their decisions.
17. For fragments of the writings of these and other figures from the history of the conservation field, consult the Getty Conservation Institute’s *Historical and Philosophical Issues in the Conservation of Cultural Heritage* (Stanley-Price, Talley, and Vaccaro 1996). Some historical accounts and summaries of individual contributions to the history of architectural conservation are available in Jokilehto (1999).
18. *Development* is used here in the World Bank sense of integrated social and economic programs for poverty reduction in disadvantaged areas of the globe. For more detail, see the World Bank Web site outlining its various programs to advance development: [www.worldbank.org/html/extdr/thematic.htm](http://www.worldbank.org/html/extdr/thematic.htm).
19. Interdisciplinary fields such as human geography, material culture, vernacular architecture, and American studies embrace the idea of a diverse choice of methodologies and a catholic approach to using them.
20. See [www.cr.nps.gov/aad](http://www.cr.nps.gov/aad); see also Low’s paper in the present volume.
21. Two Web sites offer information and a wealth of examples on PRA and rapid rural assessment (RRA) approaches: The Institute of Development Studies, based in England ([www.ids.ac.uk/ids](http://www.ids.ac.uk/ids)) and the United Nations University ([www.unu.edu/unupress/food2](http://www.unu.edu/unupress/food2)). See also Bell and Morse (1999) for a summary.



22. The overlay mapping of landscape architect and planner Ian McHarg is an example of a methodology developed through mapping (McHarg 1992).
23. Publications of Common Ground ([www.commonground.org.uk](http://www.commonground.org.uk)) include Greeves (1987); for an example of mental mapping of communities as an educational tool, see the 1998 Getty Research Institute project "Mapping Local Knowledge" (available at [www.getty.edu/research/programs/public/llk/](http://www.getty.edu/research/programs/public/llk/)).
24. This discussion of economic methods builds on the outline of issues and methods published in *Economics and Heritage Conservation* (Mason 1999). The work of economists to measure cultural values is not dealt with exhaustively here, even though economists' efforts to deal with cultural value constitute one of the critical issues in this research. Economic methods and concepts are surveyed in Throsby (2001), in Klamer and Zuidhof's paper in Mason (1999), and in Throsby's and Mourato and Mazzanti's papers in this volume.
25. More detail is presented in Throsby (2001).
26. Throsby's development of sustainability principles for heritage conservation is built on the notion of heritage understood as a form of cultural capital. The "capital" metaphor is potentially quite useful. It brings to the surface the need to invest in heritage and to expect a flow of benefits from it. Likewise, it highlights the reality that trade-offs must be made (not everything can be conserved), the reality that values must be balanced, and so forth. The notion of cultural capital, like "values," could become a way of linking many of the issues raised in this research—strategic, methodological, political, professional—because it converts all types of heritage into a generalized unit (cultural capital), enabling one to compare conservation resources, processes, and decisions. The downside is that the capital metaphor suggests that heritage is in some manner exchangeable—whereas conservation professionals generally subscribe to an a priori definition that all heritage is unique and not exchangeable. This concept of substitutability—a fundamental part of the concept of capital—is therefore problematic. One way of tackling this problem is making distinctions about heritage that is seen as "tradable" and therefore perfectly substitutable with other forms of capital and even "consumable," versus heritage that is "sacred" and not substitutable. The idea of tradable or nonsacred heritage highlights the fact that conservation inherently involves trade-offs against other social investments and priorities. This understanding requires that heritage and conservation be seen not in isolation but, rather, as thoroughly embedded in larger social contexts.
27. The tradable/sacred distinction is outlined in English Heritage's (1997) discussion paper on sustainability. It also aligns with the argument made by David Lowenthal and others that heritage is a changeable set of things. In order for heritage to remain relevant to contemporary society, some things have to be continually valorized and added to the heritage, while other things are devalorized and, in effect, destroyed. Therefore, heritage implies destruction, just as it implies conservation. See Lowenthal in Avrami, Mason, and de la Torre (2000).
28. There is an extensive literature on indicators used in sustainable ecological development. Bell and Morse (1999) and Hart (1999) are excellent sources on this.

---

## References

Australia ICOMOS. 1999. The Burra Charter. Revised. [www.icomos.org/australia/](http://www.icomos.org/australia/).

Avrami, E., R. Mason, and M. de la Torre, eds. 2000. *Values and Heritage Conservation*. Los Angeles: Getty Conservation Institute.

Bell, S., and S. Morse. 1999. *Sustainability Indicators: Measuring the Immeasurable*. London: Earthscan Publications.

Denzin, N., and Y. Lincoln, eds. 1994. *Handbook of Qualitative Research*. Thousand Oaks, Calif., and London: Sage Publications.

English Heritage. 1997. *Sustaining the Historic Environment: New Perspectives on the Future*. English Heritage Discussion Document. London: English Heritage.

Frankfort-Nachmias, C., and D. Nachmias. 1996. *Research Methods in the Social Sciences*. Fifth ed. New York: St. Martin's.

Freudenburg, W. 1999. Tools for understanding the socioeconomic and political settings for environmental decision making. In *Tools to Aid Environmental Decision Making*, ed. V. Dale and M. English. New York: Springer.

Frey, B. 1997. The evaluation of cultural heritage: Some critical issues. In *Economic Perspectives on Cultural Heritage*, ed. M. Hutter and I. Rizzo. London: Macmillan.

Greeves, T. 1987. *Parish Maps: Celebrating and Looking after Your Place*. London: Common Ground.

Hart, M. 1999. *Guide to Sustainable Community Indicators*. North Andover, Mass.: Sustainable Measures.

Hutter, M., and I. Rizzo, eds. 1997. *Economic Perspectives on Cultural Heritage*. London: Macmillan.

Jokilehto, J. 1999. *A History of Architectural Conservation*. London: Butterworth-Heinemann.

Kellert, S. 1996. *The Value of Life: Biological Diversity and Human Society*. Washington, D.C.: Island Press.

Kerr, A. 1999. Public participation in cultural resource management: A Canadian perspective. Draft manuscript, March 31.

Kerr, J. 2000. *Conservation Plan: A Guide to the Preparation of Conservation Plans for Places of European Cultural Significance*. Fifth ed. Sydney: National Trust of Australia (NSW).

Lipe, W. 1984. Value and meaning in cultural resources. In *Approaches to the Archaeological Heritage*, ed. H. Cleere. New York: Cambridge University Press.

Low, S. 1981. Social science methods in landscape architecture design. *Landscape Planning* 8:137–48.

- McHarg, I. [1967] 1992. *Design with Nature*. Reprint, New York: John Wiley & Sons.
- Marquis-Kyle, P., and M. Walker. 1992. *The Illustrated Burra Charter*. Sydney: Australia ICOMOS / Australian Heritage Commission.
- Mason, R., ed. 1999. *Economics and Heritage Conservation*. Los Angeles: Getty Conservation Institute.
- Pearson, M., and S. Sullivan. 1995. *Looking after Heritage Places: The Basics of Heritage Planning for Managers, Landowners, and Administrators*. Carlton, Victoria: Melbourne University Press.
- Reigl, A. [1902] 1982. The modern cult of monuments: Its character and its origins. Reprint, trans. D. Ghirardo and K. Forster. *Oppositions* 25:21–51.
- Rolston, H., III. 1988. *Environmental Ethics: Duties to and Values in the Natural World*. Philadelphia: Temple University Press.
- Sanoff, H. 2000. *Community Participation Methods in Design and Planning*. New York: John Wiley & Sons.
- Satterfield, T. Forthcoming. In search of value literacy: Suggestions for the elicitation of environmental values. *Environmental Values*.
- Serageldin, I., and A. D. Steer. 1994. *Valuing the Environment: Proceedings of the First Annual International Conference on Environmentally Sustainable Development Held at the World Bank*. Washington, D.C.: World Bank.
- Sexton, K., et al., eds. 1999. *Better Environmental Decisions: Strategies for Governments, Businesses, and Communities*. Washington, D.C.: Island Press.
- Stanley-Price, N., M. Talley Jr., and A. Vaccaro, eds. 1996. *Historical and Philosophical Issues in the Conservation of Cultural Heritage*. Los Angeles: Getty Conservation Institute.
- Tainter, J., and J. Lucas. 1983. Epistemology of the significance concept. *American Antiquity* 48(4):707–19.
- Throsby, D. 2001. *Economics and Culture*. Cambridge: Cambridge University Press.
- Tomlan, M., ed. 1998. *Preservation of What, for Whom?: A Critical Look at Historical Significance*. Ithaca, N.Y.: National Council for Preservation Education.
- us/ICOMOS. 2000. Thematic statement of ICOMOS International Conference, Philadelphia, April. [www.icomos.org/usicomos](http://www.icomos.org/usicomos) .

# Anthropological-Ethnographic Methods for the Assessment of Cultural Values in Heritage Conservation

By SETHA M. LOW

---

## Introduction

This paper will review qualitative methods in anthropology that are available for assessing sociocultural values at heritage sites. In this publication, the Getty Conservation Institute is interested in exploring existing methods that could be applied or modified to elicit stakeholder and community values. Through the surveying and evaluating of these methods, a methodological approach and specific techniques could be identified that would help conservation professionals and managers understand the complexity of social relations and cultural dynamics at play in the conservation planning and development of heritage sites. Rapid Ethnographic Assessment Procedures (REAPS) used at National Park Service (NPS) historical parks are highlighted as useful methods of assessment for planning, design, reconstruction, and management of heritage sites.

This discussion begins with a brief overview of qualitative methods in cultural anthropology. Ethnographic and observational approaches seem most appropriate to the heritage conservation task because of their individual and group levels of analysis. Two other methodologies—constituency analysis and ethnosemantics—are also applicable to heritage sites. The limitations of each are discussed, and a third methodology, the REAP, is proposed as the most inclusive and useful for solving heritage conservation problems. REAP methodologies grew out of agricultural and national park projects, and when they are applied to planning and design problems, they integrate elements of constituency analysis used in landscape architecture as well as ethnosemantic methodologies used in historic preservation projects. The remainder of the discussion focuses on the REAP and its application to cultural heritage conservation.

---

## Anthropological-Ethnographic Methods for the Assessment of Cultural Values at Heritage Sites

### Overview of Qualitative Methods in Cultural Anthropology

Qualitative methodologies in cultural anthropology are characterized by their humanism and holism (a philosophical position that argues that humans and human behavior cannot be understood or studied outside the context of a person's daily life, life world, and activities). Methodological strategies consonant with this definition include: cognitive, observational, phenomenological, historical, ethnographic, and discourse approaches to research (Low 1987b). Each of these approaches focuses on distinct aspects of the social world, and the approaches vary in terms of their appropriateness for different problems, their levels of analysis, and the role of the researcher. Although these determinations are not fixed and may change over time, they provide a preliminary framework for selecting the qualitative methods that would be most appropriate for eliciting and assessing sociocultural values at heritage sites. While all qualitative methods have some utility in evaluating heritage sites, some approaches have distinct advantages. For this discussion, methodologies are arranged in order of their complexity and scope of inquiry, beginning with cognitive and observational approaches that focus on one dimension of human activity—a mental or behavioral process—followed by phenomenological and historical approaches that integrate human activity with the environmental context, and concluding with ethnographic and discourse approaches that include human activity, environment, and social, cultural, and/or political context.

Cognitive approaches include both the study of cognition as a mental process—often reflected in language—and cognition as a set of categories that structure perception through the attribution of meaning. One application is in the area of ethnosemantics (the study of cognitive meaning from the culture's own point of view),

discussed as a separate methodology later in this paper. Semantics refers to the linguistic analysis of the structure of meaning in a language and culture. Most semantic work is based on the intensive interviewing of key informants to produce linguistic taxonomies, hierarchies of concepts and terms that describe an individual's understanding of the world and that collectively describe the culture (Low 2000a). For instance, a heritage conservation professional working with an anthropologist could develop a taxonomy of house types by asking informants to name all the kinds of houses that exist in their town. Once a list of all the possible house types is developed, the researcher then asks what distinguishes each house type and repeats the procedure until a complete linguistic map of all housing kinds and their characteristics has been produced. The term *ethnosemantics* in this paper refers to a modified semantic procedure that focuses on the semantic structure of one group of people in relation to their local environment. When used in studies of the built environment, the term also incorporates the role that language plays not only as a structural or taxonomic system but as symbolic communication about important cultural ideas.

Observational methodologies in which overt behavior is observed by the researcher are the mainstay of qualitative researchers, and they include simple observation of activities and behavioral mapping, as well as elaborate systems of time-lapse photography of public spaces (Whyte 1980), ethnoarchaeological techniques (Kent 1984), and nonverbal communication strategies for understanding the built environment (Low 2000b; Rapoport 1982). For instance, William H. Whyte spent seven years filming street behavior with a small movie camera perched on the top of Rockefeller Center (Whyte 1980). The analysis of these observational films produced a set of urban design principles that have governed urban public space zoning in New York City for the past twenty years. Ethnoarchaeological techniques combine traditional archaeological data obtained from on-site excavation and stratification analysis with historical documents and ethnographies of local groups that may be using the site in ways similar to their local ancestors. The idea is to use observations of contemporary peoples' built environment, everyday behavior, and social and ritual activities to interpret archaeological findings (Kent 1984). Finally, observation of nonverbal behavior has been used to theorize about how people understand a site. Rapoport argues that fixed features of a site, such as the buildings, trees, and elements that cannot be easily moved, and nonfixed features, such as furniture, produce very different kinds

of meanings (Rapoport 1982). Nonfixed features are more important for the understanding of nonverbal communication. In all of these cases, observational techniques are at the core of the research project or theoretical explanation.

Phenomenological approaches differ in their epistemological point of view in that the object of study is not separated from the act of perceiving. Studies focus on "place" and on "how place grows out of experience, and how, in turn, it symbolizes that experience" (Richardson 1984, 65). The emphasis is on the individual perceiver and his or her experience as empirical evidence of the world.

Historical approaches locate a particular site, place, or built form in its temporal context. From a conservation perspective, historical approaches are very important for architectural historians, archaeologists, and others, because they can provide insight into past values of the site and how perceptions and significance have changed over time. Conservators, however, have to bring into consideration the values of current users as well as those of other communities (such as experts) and past users. While historical approaches address past users and the study of material culture and its evolution, they do not address the current users of the site, who are best understood through ethnographic approaches.

Ethnographic approaches are broader and include the historical, as well as the social and political, context of the site as a means of understanding contemporary sociocultural patterns and cultural groups. Ethnographic research—the process of describing a culture—has the ability to predict local response to design and planning proposals accurately, and it can help evaluate complex alternatives through systematic cultural understanding.

Depending on the magnitude of the geographical area, the length of time spent, and the historical depth of the study, ethnography produces a complete cultural description of a site, as well as descriptions of interconnected nonlocal communities and of relevant adjacent sites. For instance, the ethnographic study of Jacob Riis Park at the edge of Brooklyn and Queens in New York City found that the restoration done by the National Parks Service (NPS) of Robert Moses's bathhouse was of little importance to new visitors to the site, who come to the beach to picnic in the shade and to enjoy family activities. These new users, mostly recent immigrants from Central and South America, are not aware of the history of the site and do not understand the fencing off of the historic "mall" area (with a direct view of the Empire State

Table 1 Qualitative methodologies in cultural anthropology: research appropriateness.

Methodological Approach	Scale/Level of Inquiry	Degree of Involvement	Research Problem
Cognitive	Individual	Minimal	Rules, ideals, and perceptions
Observational	Group (individual)	Minimal	Behavior, observable actions, and activity sites
Phenomenological	Individual	Total	Experience of places and events
Historical	Societal	Minimal	Social and cultural trends, comparison of sites
Ethnographic	Group (individual)	Moderate	Cultural motivations, norms, values, intentions, symbols and meanings
Discourse	Individual (societal)	Moderate	Underlying meanings of speaking / conversation

Building). Instead, they are upset that so many of the few remaining trees on the site are cordoned off. Their response has been to ignore the fencing and to picnic under the trees wherever possible. The ethnographic study illuminated this source of conflict, providing the possibility of better communication, design, and planning of the historic site in the future.

Discourse approaches include social experience, the reciprocal acts of speaking and being spoken to, and the emergent product of that speaking, the object of the conversation. Discourse approaches consider the object of study, the text, the context, and the interpretation of the object as one continuous domain. Discourse approaches are only beginning to be used in applied settings because of the difficulty of gathering the data and because of their highly specialized forms of transcription and notation.

In Table 1, each methodological approach is evaluated by (1) the focus or scale of the research—individual, group, or societal; (2) the degree of involvement and/or contact with the research subject—minimal, moderate, or total; and (3) the kind of problem most often associated with the methodology. The utility of each methodology is derived from the researcher’s need to answer questions at a specific scale, in a time frame that controls the degree of involvement, and within the domain of a particular research problem. The application criteria derive from the same decision variables.

These approaches are appropriate for different kinds and levels of research. For instance, the individual-based methodologies (cognitive, phenomenological, and discourse) are excellent for eliciting individual users’ experiences and perceptions of the site, while the societal-based approaches (historical and discourse) provide methods that uncover historical significance and social change. All of these methods answer some research problem

of concern to the heritage conservation practitioner; however, it is valuable to highlight the observational and ethnographic approaches that focus on the group and the individual within the group. These two methodologies address the core objective—that is, to identify local site use and disuse and, even more important, to understand the motivations, norms, values, intentions, and symbolic meanings underlying that use and disuse. For example, while phenomenological research can elicit statements of place attachment and place identity, ethnographic research describes the place attachment of groups within the geographical community. Furthermore, ethnographic approaches focus on sociocultural values as a central part of the research endeavor.

Ethnography combined with observational methodologies requires considerable time in the field to complete—usually up to a year or more. However, working with design and planning professionals—as well as conservation practitioners—requires brief, direct procedures for understanding a particular site. Two of these strategies have been used in historic landscape preservation projects and are discussed because of their appropriateness—they combine observation and ethnography—and because they offer methodological shortcuts that allow for short-term application during an ongoing, site-specific project.

### Constituency Analysis: A Methodology for Landscape Architecture

The author developed an appropriate social science research method for landscape architecture<sup>1</sup> as a consequence of working as an anthropologist with design faculty and students. They needed a way to organize, collect, and conceptualize social data relevant to design problems. Constituency analysis was an attempt to integrate the

complex, recursive process of design with social data. Table 2 summarizes the five-stage design process, which includes three social data phases, stages 1, 2, and 5, that necessitate anthropological methods. The first stage is problem formulation, composed of client definition and problem clarification. For any project there are a number of possible clients and user groups, including a paying client (often the federal government); specific user groups, communities, or neighborhoods on or near the proposed site; and often potential regional or national constituencies that may use the site in the future. Interviews, an analysis of influence processes, and other techniques are necessary to generate a list of all the clients, or stakeholders, involved in the design.

Once the problem and the client are defined, the designer begins to collect data on the perceptions of the residents and future users of the site. This data-collection stage takes the form of an identification of constituencies, as well as of their perceived needs, desires, and social conflicts. Constituency identification is the enumeration and description—that is, with regard to social, cultural, and demographic characteristics—of the kinds of people living on or near the project site. Any number of sampling techniques and methods, from participant observation of local communities to a questionnaire survey of randomly selected residents and users, can be employed to collect such data. Once constituencies are described and categorized into groups, the second task—identifying constituency perceptions, needs, and desires—begins. This information, which becomes the basis of later physical design decisions, is more difficult to collect, in that direct elicitation techniques are not usually successful. The methods suggested for constituency needs and desires assessment are therefore indirect techniques that attempt to stimulate response and opinion concerning possible land use and physical design features; these techniques include expert interviews, mental maps of patterns of site utilization and perceptions, and projective tests. A final

step in the data-collection procedure includes the identification of constituency conflicts concerning issues that impact the future success of any planned change. Depending on the project, an analysis of constituency conflicts may become part of the programming procedure, especially when the project objective is to resolve conflicting land uses.

The third and final stage before implementation and physical design is the construction of a program, a set of specific objectives and detailed goals upon which the physical design is based. The program orders and applies the constituency needs and desires to physical design decisions. Finally, an evaluation of the design, based on original project objectives and social criteria, requires some form of measurement of social change. A number of anthropological methodologies have been developed to monitor the social impact of large-scale projects, including the REAP discussed below. Social change is often measured by a questionnaire survey of previously defined outcome variables; however, qualitative techniques, such as participant observation and structured interviewing, can be used when the design intervention is at a relatively small scale.

Constituency analysis is an excellent system for integrating constituency identification into the planning and design process. The process of client identification is similar to stakeholder identification; and constituency identification, constituency needs and desires assessment, and the working out of constituency conflicts are applicable to most heritage sites. The drawback to this methodology, however, is that some sites do not have clear constituencies—or there might be clear constituency groups that do not, however, match or correlate with cultural values on the site. For instance, local homeowners, with concerns about a nearby site, might not be visible if the analyses are focused on users of the site. These reasons have led to the development of methodologies, such as the REAP, that are more flexible than constituency analysis and that

Table 2 Constituency analysis.

Stage	Tasks
Stage 1: Problem formulation	Client definition; problem clarification
Stage 2: Data collection	Constituency identification; needs and desires assessment; constituency conflicts
Stage 3: Programming	Data interpretation; data application
Stage 4: Physical design	Conceptual design; physical framework
Stage 5: Evaluation	Measurement of change; interpretation of meaning

utilize a wider set of techniques and methods. Nonetheless, the sequencing of stages and the emphasis on the reiterative nature of design and planning problems are useful in thinking about developing a cultural values assessment process for heritage conservation projects.

### **Ethnosemantic Methodology: Design and Translation at Historic Sites**

Ethnosemantic techniques have been used in preservation projects to translate local values into elements of material culture that could then be respected and preserved. The separation between the perceptions of architectural historians and those of the public is increased by differences in professional and popular culture (Low 1982). Architects and architecturally trained historians, as well as most conservation professionals, participate in a process of professional socialization that provides a common language, set of symbols, value structure, and code of rituals and taboos. The public does not share this perceptual system but, instead, holds images and preferences that are embedded in its own beliefs, customs, and values. Conflict may arise when these two cultures compete for control over land use, building, landscape, and/or preservation decisions. In such a situation, the methodological and conceptual skills of someone trained in ethnosemantics or other anthropological and linguistic methodologies are useful to resolve the cultural conflict. When conservation managers and planners face decisions that they know may be fiercely contested, looking for another way to translate the cultural differences, through a method such as those described, may solve the disagreement by locating the middle ground or appropriate language necessary to proceed with the plan, design, or any other desired change.

Ethnosemantic methodologies assume that culture is encoded in language that can be elicited through a linguistic, taxonomic analysis (see the overview of qualitative methods above for further discussion). Structured questions organize responses into taxonomic categories to create cultural domains of meanings. These methods have been applied in a modified form to the historic preservation of buildings and landscapes. Research on the ethnosemantic structure of Greek village houses uncovered their traditional social status meanings (Pavlidis and Hesser 1989) and translated culturally appropriate details of eighteenth-century stone farmhouses in a rural Pennsylvania community into standards for infill architectural design (Low and Ryan 1985).

Both studies began by determining the range of architectural variation in the local community, investigating the local meanings attributed to the variation, and then verifying those meanings through an ethnosemantic method. Pavlidis and Hesser photographed architectural details of Greek village houses that they suspected were symbolic of a family's social standing based on their previous interviewing and house survey (Pavlidis and Hesser 1989). They then presented these photographs to the community and asked people to tell them what each architectural detail meant. The responses of community members were used to ensure that the researchers' interpretation of symbolic meaning reflected that of the community.

The study of historic buildings in Oley, Pennsylvania, was designed to elicit what local residents thought were meaningful characteristics of their stone farmhouses (Low and Ryan 1985). The project was part of a rural preservation program and utilized a historical buildings survey as a guide to architectural variation in the community. A representative blue ribbon panel was interviewed as to the degree of "Oleyness" for each of the architectural details found in the survey. The research linked architectural elements with cultural images through the exploration of "Oleyness" as a culturally relevant cognitive domain.

---

### **Rapid Ethnographic Assessment Procedures**

#### **Review of Rapid Assessment Methodologies**

Rapid assessment methodologies<sup>2</sup> have been adapted from rural and agricultural development projects in developing nations. In these contexts, multidisciplinary teams of experts investigate socioeconomic conditions in a particular area with regard to agriculture and resource management, usually in less than a month or even a week (Ervin 1997). Beebe, surveying the literature on rapid assessment procedures, outlines three basic principles: a systems perspective, triangulation of methods, and an iterative process of data collection and analysis (Beebe 1995). The rapid assessment is used to identify the elements of a local system and how they interrelate, through a qualitative data collection process of uncovering local knowledge. The semistructured interview, the expert interview, and the focus group are characteristic elements of a triangulated methodology. The general approach—

which is based on the assumption that researchers often do not know the right questions in advance—is to get people to talk rather than to answer direct questions.

Rapid assessments differ from traditional qualitative research in that more than one researcher is always involved, researcher-team interaction is critical to the methodology, and results are produced much faster. Rapid assessment is “especially relevant when time constraints preclude use of intensive qualitative methods by a single researcher and when the different perspectives of the team members (including local participants) are essential for understanding the situation” (Beebe 1995, 42).

Ervin used the term “relatively rapid” in the context of a six-month community needs assessment for Saskatoon, Saskatchewan (Ervin 1997). The research team worked under contract to the local United Way to rank the community’s social service priorities. Because of time and budget limitations, Ervin used six qualitative methods, including focus groups, key informant interviews, review of existing reports, Delphi questionnaires (a process in which experts participate in the research anonymously, through writing), and public forums. The resulting report ranked community needs, such as the elimination of hunger and greater emphasis on preventative services.

Rapid assessment as a specific tool for ethnographic research—and in some cases at heritage sites—has been written about in the *CRM (Cultural Resource Management) Bulletin*, a periodical published by the NPS. The agency’s Applied Ethnography Program defines seven ethnographic research methodologies, among them REAPS, that are used to investigate and describe cultural relationships between particular local communities and park resources and that are sometimes used to support nominations of lands and sites to the National Register of Historic Places (Joseph 1997). The REAP is appropriate for project-driven applications because it provides a great deal of cultural information useful for planning purposes within a short time—generally within a four-month time frame (NPS 2000; Liebow 1987). The short time frame of a REAP is a crucial advantage in the event of substantial proposed construction, which involves major commitments of funds, negotiation of political support, and timely project development.

REAP first employed ethnographic research in connection with western Native American communities having long-standing associations with certain parklands. These lands—natural resources and, in the case of objects and structures, cultural resources—are required by Native Americans or other local communities for their continued cultural identity and survival. NPS terms these lands “ethnographic resources” and calls the peoples associated with them “traditionally associated” or “park-associated” peoples (Crespi 1987). In providing systematic data on local lifeways, applied ethnographic research is intended to enhance the relationships between park management and local communities whose histories and associations with park cultural resources are unknown or poorly understood (Crespi 1987; Bean and Vane 1987; Joseph 1997). In many newer parks, NPS shares jurisdiction with other federal agencies, state and local governments, modern Native American nations, or other culturally distinctive communities. The resulting complexity of planning tasks makes ethnographic research with affected communities especially helpful.

The literature points to several kinds of benefits from ethnographic research. One is in the area of conflict management—for example, where local communities anticipate adverse impacts from new park designations or from changes to existing parks. Wolf describes the contribution made by ethnographic research to community relations in the difficult process of establishing a national historic park around sites in Atlanta associated with the life of Martin Luther King Jr. Ethnographic knowledge helped management identify opportunities for compromise and potential mitigating measures (Wolf 1987). The process of ethnographic research with culturally distinctive communities affected by construction projects can give a certain credibility to agency decision making (Liebow 1987).

Community empowerment is another benefit, in that relationships established create a dialogue between park officials and local neighborhood and cultural groups that would not otherwise have a voice in the park planning process. Joseph stresses the collaborative nature of the applied ethnographic research done by NPS, where ordinary citizens and community leaders participate alongside elected officials, park managers, and the researchers (Joseph 1997). Low suggests that most preservation problems in cultural landscapes—especially vandalism, underutilization, and neglect—could be prevented with more dialogue between the community and the governmental agency (Low 1987a).



A third important benefit of ethnographic research is to present and represent the cultural heritage of local communities within the overall programming of park resources. Ethnographic information is useful in presentation, particularly for parks like Minuteman, in Massachusetts, that include existing communities within their borders. Minuteman has endeavored to restore and preserve farming as a traditional cultural practice within the historic environment the park preserves and interprets. Information that may be uncovered only through ethnography, such as the gendered division of labor on family farms, may be crucial to the continued effective management of a generations-old practice (Joseph 1997). Where the presentation of historic objects is concerned, ethnographic information, gained from living members of the associated cultural group, can reveal uses and meanings not apparent in the objects themselves (Brugge 1987).

“Most cultural landscapes are identified solely in terms of their historical rather than contemporary importance to the community” (Low 1987a, 31), privileging historical meanings over those of the geographically and/or culturally associated communities. This oversight often promotes friction and local disagreements that can be solved through the knowledge produced by a REAP.

### **REAP Methodology**

In a REAP, a number of methods are selected to produce different types of data from diverse sources that can be triangulated to provide a comprehensive analysis of the site. A description of each method is briefly presented below. Table 3 summarizes the products and outcomes of each method.

#### **PHYSICAL TRACES MAPPING**

Physical traces maps record the presence of liquor bottles, trash, and clothing, the erosion of plantings, and other traces of activities. These maps are completed based on data collected early in the morning at each site. Records of physical evidence of human activity and presence provide indirect clues as to what goes on at these sites during the night. Physical traces mapping presumes that there is a base map of resources and basic features available which can be used to locate the physical traces. Otherwise, part of the task is to create such a map, both for the physical traces and for the behavioral maps discussed below. At many archaeological sites, a base map might not be available—a condition that would add another step to the research process.

#### **BEHAVIORAL MAPPING**

Behavioral maps record people and their activities and locate them in time and space. Such maps arrange data in a way that permits planning and design analyses of the site, and these maps are very useful in developing familiarity with the everyday activities and problems of a site. They are most effectively used in limited park areas with a variety of social and economic uses, where the researcher can return repeatedly to the various social spaces during the day.

#### **TRANSECT WALKS**

A transect walk is a record of what a community consultant describes and comments upon during a guided walk of the site. The idea is to include one or two community members as research team members, in order to learn about the site from the community member’s point of view. In most REAPS, local consultants work with the researcher as a collaborator. In the transect walk, however, this relationship is particularly important, in that the method is dependent on the quality of the relationship between the collaborator and the researcher, and on the ability of the community member to explain and discuss the landscape.

#### **INDIVIDUAL INTERVIEWS**

Individual interviews are collected from the identified populations. The sampling strategy, interview schedule, and number of interviews vary from site to site. In most cases, on-site users and residents who live near the site are interviewed, but in specific situations, interviews might be collected more broadly.

#### **EXPERT INTERVIEWS**

Expert interviews are collected from those people identified as having special expertise to comment on the area and its residents and users, such as the head of the vendors’ association, neighborhood association presidents, the head of the planning board, teachers or principals in local schools, pastors or ministers of local churches, and representatives from local parks and institutions.

#### **IMPROMPTU GROUP INTERVIEWS**

Impromptu group interviews occur where people gather outside of public places or at special meetings set up with church or school groups. The goal of group interviews (as opposed to individual interviews or focus groups) is to collect data in a group context, as well as to provide an educational opportunity for the community. Impromptu group interviews, which are open-ended and experimen-

tal, include any community members who are interested in joining the discussion group.

#### FOCUS GROUPS

Focus groups are set up with those people who are important in terms of understanding the site and local population. As opposed to the large, open group interviews, the focus groups consists of six to ten individuals selected to represent especially vulnerable populations, such as schoolchildren, seniors groups, and physically challenged groups. The discussions are conducted in the language of the group; they are directed by a facilitator and are tape-recorded.

#### PARTICIPANT OBSERVATION

The researchers maintain field journals that record their observations and impressions of everyday life at the site. They also keep records of their experiences as they interact with users and communities. Participant observation is a valuable adjunct to the behavioral maps and interviews. It provides contextual information and data that can be compared to what is seen, and such observation is said to enable accurate data interpretation.

#### HISTORICAL AND ARCHIVAL DOCUMENTS

The collection of historical documents and review of relevant archives, newspapers, and magazines begins the REAP process. At historically significant sites, this process may be quite extensive, especially if secondary sources do not exist. The importance of a careful review of historical documents should be emphasized, since it is through a thorough understanding of the history of the site that areas of cooperation and conflict often become clear and identifiable.

#### ANALYSIS

Interview data are organized by coding all responses, and then content is analyzed by cultural or ethnic group and study question. Transect walks, tours, and interviews are used to produce cultural resource maps for each group. Focus groups determine the extent of cultural knowledge in the community, and they can identify the areas of conflict and disagreement within the community. Mapping, transect walks, individual and expert interviews, and focus groups provide independent bodies of data that can be compared and contrasted, thus improving the validity and reliability of data collected from a relatively small sample. As in all ethnographic research, the use of interviews, observations, and field notes—as well as knowledge of the cultural group patterns and local politics—are used to help interpret the collected data.

A number of procedures are used to analyze the data. First, the resource maps are produced by an overlay method that combines the behavioral maps, physical traces, and participant observation notes. These maps are descriptive, in that they summarize activities and disturbances on the site. Second, a research meeting is held in which each participant summarizes what he or she has found in the interviews. These are general observations that guide the researcher or research team as more precise coding strategies are developed. This synthetic stage is quite important, in that it provides a place to start thinking about what has been found. These general summaries are used to explore theoretical approaches and to prioritize the coding procedure.

The third step is to take each generalization and break it into a set of codes that can be used to analyze the field notes. Once this process is completed, the interview questions are reviewed, and a similar coding scheme is developed. The interview coding relies on the findings of the maps, on the field notes (just discussed), and on the structure of the questions themselves. This is the lengthy part of the analysis process, and it requires discussion of the research team with the client and, in some cases, with the individual stakeholders. Some coding schemes may require multidimensional scaling and a quantitative analysis, although qualitative content analysis is usually adequate in a REAP.

Because the REAP is a rapid procedure, the number of interviews is usually under 150, and therefore, they can be analyzed by hand. The advantage of a qualitative analysis procedure is that the data are not abstracted from their context, and so they retain their validity and detail. The final step involves a triangulation of the various analyses and a search for common elements and patterns of behaviors and the identification of areas of conflict and differences, both in the nature of the data and in the groups themselves.

---

### **Application of REAPs for Heritage Conservation Sites**

TWO NPS projects—the first on Independence National Historical Park in Philadelphia, which focused on the importance of ethnicity and cultural representation in park use; the second, an evaluation of access alternatives to Ellis Island, New York—are presented to provide possible prototypes for developing a methodology for heritage conservation. The issues involved—identifying

Table 3 Products and outcomes of research methods used in the REAP.

Method	Data	Product	What Can Be Learned
Physical traces mapping	Collected trash, patterns of erosion on site	Description of nighttime activities	Identifies evening activities not observed
Behavioral mapping	Time/space maps of site	Description of daily activities on site	Identifies cultural activities on site
Transect walks	Transcribed interviews and consultants' map of site	Description of site from community members' points of view	Community-centered understanding of the site; local meaning
Individual interviews	Interview sheets	Description of responses of the cultural groups	Community responses and interest in the site
Expert interviews	In-depth interview transcriptions	Description of responses of local institutions and community leaders	Community leaders' interest in the site planning process
Impromptu group interview	Transcription of meeting	Description of group perspective, educational value	Group consensus of issues and problems
Focus groups	Tape-recorded and transcribed	Description of issues that emerge in small group discussion	Elicits conflicts and disagreement within the cultural group
Participant observation	Field notes	Sociocultural description of the context	Provides context for study and identifies community concerns
Historical and archival documents	Newspaper clippings, collection of books and articles, reading notes	History of the site's relationship to the surrounding communities	Provides historical context for current study and planning process

the stakeholders, community, and local users; eliciting their cultural values; understanding the meanings that the site holds for various groups; and giving voice to their concerns and perspectives—are similar to the issues addressed by a conservation professional who must evaluate a site. Each case study is presented in detail so that conservation practitioners can adapt the procedure to their own needs.

### **Independence National Historical Park: Ethnicity, Use, and Cultural Representation**

The idea of a historical national park in Philadelphia originated with the Federal Historic Sites Act of 1935, which authorized the NPS to engage in research and educational and service programs and to protect, preserve, and maintain historic buildings and sites for public use. Planning and site acquisition began in the late 1940s; demolition, site preparation, and construction took place throughout the 1950s.

The Independence National Historical Park's enabling legislation and primary historic resources focus on Independence Hall and related structures as the scene of the central events that resulted in the creation of the United States of America. These structures are the physical reminders of the epic struggle for freedom and

self-government, as they relate not only to the founding of the nation but also to the birthplace of modern democratic government worldwide. The Liberty Bell, an international icon and one of the most venerated objects in the park, evolved as a symbol of liberty because of its association with various struggles for freedom, including the events of 1776 to 1789.

The historical park project became part of a larger effort in the 1950s to renew Center City Philadelphia. The epicenter of the renewal effort was Society Hill, an area adjacent to the new national park. Because of the proximity of this neighborhood to the projected park area as well as to downtown and because of the high quality of much of its building stock, the city saw in the national park planning process an opportunity to restore the racially and culturally heterogeneous neighborhood to its colonial-period status as a wealthy residential area. The name Society Hill was rediscovered and put to use in making over the district's image.

Sections of Society Hill were designated as redevelopment areas. Homeowners were given the choice of restoring their properties according to strict historic preservation guidelines adopted by the planning authorities or of selling to the redevelopment authority. Since few could afford the costly work of historic restoration, most sold their homes. The city then offered the properties for

sale at a nominal price to buyers who could prove that they had the financial resources to restore them in accordance with the guidelines. The banks, the real estate community, and the news media cooperated with the city in creating a favorable image of the redevelopment area, thereby creating a market of affluent, mostly white buyers. Thus, over a period of roughly fifteen years, the predominantly poor, heterogeneous community of long standing was dispersed and replaced by a new community of predominantly white professionals.

The social and physical upheavals involved in creating Independence National Historical Park and Society Hill did little to foster communication with local communities. The extensive demolition and erasure of the city fabric removed many of the settings that had meaning for members of local communities. In particular, the uprooting of the historic African-American community from what is now Society Hill is a legacy that has made it difficult to build ties between the park and that community.

Nevertheless, the NPS supports numerous community outreach programs and has recently created the *Yellow Fever* exhibit, which focuses on the heroic roles of African Americans during this deadly plague. Furthermore, the NPS receives and responds to numerous requests for park use from the many cultural and ideological communities in greater Philadelphia.

In 1994, Independence National Historical Park began developing a general management plan that would set forth basic management philosophy and provide strategies for addressing issues and objectives over the next ten-to-fifteen-year period. The planning process called for extensive public participation, including a series of public meetings, televised town meetings, community tours, and planning workshops. As part of this community outreach effort, the park wanted to work cooperatively with local ethnic communities to find ways to interpret their diverse cultural heritages within the park's portrayal of the American experience. The study, therefore, was designed to provide a general overview of park-associated ethnic groups, including an analysis of their values and the identification of cultural and natural resources that are used by the various groups or are culturally meaningful to them.

The research team spent considerable time interviewing cultural experts and surveying the neighborhoods located near Independence National Historical Park. Based on these interviews and observations, four local neighborhoods were selected for study: Southwark for African Americans, Little Saigon for Asians and Asian

Americans, the Italian Market Area for Italian Americans, and Norris Square for Latinos. These neighborhoods were selected based on the following criteria: (1) they were within walking distance of the park (except for Norris Square); (2) they had visible spatial and social integrity; and (3) there were culturally targeted stores, restaurants, religious organizations, and social services available to residents which reinforced their cultural identity. The Jewish community could not be identified with a spatial community in the downtown area; therefore, members of both Conservative and Orthodox synagogues in the Society Hill area were interviewed as a "community of interest," rather than as residents of a physically integrated area. In thirty-six days of fieldwork, 135 people were consulted in the form of individual and expert interviews, transect walks, and focus groups. Table 4 presents the product and outcome of each method utilized.

The data were coded and analyzed by cultural group and study question. All places in and around the park with personal and cultural associations for the research participants were recorded on cultural resource maps. One map was prepared for each cultural group.

One of the goals was to involve and educate community members about the park planning process, as well as to learn their thoughts about the park. They were considered research "collaborators" rather than informants, and at the conclusion of the interview, they were given a form that could be mailed back to the park with written suggestions and comments on the park's future use.

#### RELEVANT FINDINGS: CULTURAL REPRESENTATION

Many participants were concerned with issues of cultural representation. Some assimilated Italian Americans and Jews were ambivalent about presenting themselves as distinct from other Americans. African Americans, in contrast, saw a lack of material and cultural representation in the park's historical interpretation. For some, the park represented the uneven distribution of public goods: "So much for them [tourists, white people] and so little for us [African Americans, working-class neighborhood residents]." Asian Americans and Latinos favored a curatorial approach less focused on national independence which, instead, integrated their immigration stories and colonial struggles into a more generalized representation of liberty and freedom within the American experience. Italian Americans, too, were interested in a more inclusive representation—one that did not end park interpretation in 1782 or 1800 but continued to the present.

Table 4 REAP methodology for Independence National Historical Park. (Adapted from Low et al. [forthcoming].)

Method	Data	Duration (days)	Product	What Can Be Learned
Behavioral mapping	Time/space maps of site	2	Description of daily activities on site	Identifies cultural activities on site
Transect walks	Transcribed interviews and consultants' maps of site, special places, special events, culturally significant areas	6	Description of site from community member's point of view; problem with using tour guides—ample data but seemed rote	Community-centered understanding of the site; local meaning; identification of sacred places
Individual interviews	Interview sheets in English, Spanish, Vietnamese, or Chinese, with map	12	Description of responses of the cultural groups in informal settings	Community responses and interest in the site
Expert interviews	In-depth interview transcriptions	10	Description of responses of local institutions and community leaders	Community leaders' interest in the site-planning process
Formal/informal discussions; participant observation	Interview sheets	20	Description of the context and history of the project; description of site needs	Provides context for study and identifies NPS and community concerns
Focus groups	Field notes, and tape recordings in English, Spanish, and Vietnamese (used facilitator and translator)	6	Description of issues that emerge in small group discussions—difficult to organize, conduct, and transcribe	Enables understanding of conflicts and disagreement within the cultural group
Historical documents	Newspaper clippings, collection of books and articles, reading notes	7	History of the park's relationship to the surrounding communities	Provides historical context for current study and planning process

Three of the cultural groups—African Americans, Latinos, and Jews—mentioned places they would like to see commemorated or markers they would like to see installed to bring attention to their cultural presence within the park boundaries. Many participants—particularly Latinos, African Americans, and Asians—saw the need for more programming for children and activities for families. Unlike the visual, pictorial experience the tourist seeks, residents in general were interested in the park's recreational potential: as a place with sociable open spaces where one can get food, relax, and sit on the grass; or as a place for civic and cultural celebrations. These residents wanted the park to be a more relaxed, fun, lively place. As a group, Latinos made the most use of the park for recreational purposes in their leisure time. Latinos were particularly interested in developing the recreational potential of the park, but their sentiments were echoed by at least a few consultants in each of the other ethnic groups.

#### RELEVANT FINDINGS: CULTURAL VALUES

The REAP demonstrated that the park holds multiple values for Philadelphians which are often overlooked because of management's emphasis on accommodating visitors. *Visitors* was a problematic term, because residents using the park do not see themselves as visitors. Treating everyone as a visitor (read *tourist*) neglects an important sense of territoriality. The resident incorporates the park into her home territory; the visitor knows she is a visitor. To the resident, the park is symbolically and functionally part of the larger landscape of the city and the neighborhood. The resident likes being surrounded by familiar sights and places, follows his/her own rhythm in moving around the city, and enjoys a proprietary right of access. Those sensibilities are offended by crowds of tourists, by the denial of free access to historic sites (that is, when not part of a tour), and perhaps by an emphasis on official interpretations. The more the park sets its landmarks off from the surrounding city, reducing everyday contact with residents, the more the objects and places lose their meaning for residents.

The REAP of Independence National Historical Park is a model for heritage sites where issues of ethnicity and culture correspond with either use or nonuse. Identifying relevant cultural or ethnic groups as constituencies that live in the local neighborhood or that traditionally have a relationship to the park, then learning about those groups and neighborhoods through the REAP methods, provides a quick but complete snapshot of the community and its diverse values, meanings, and sense of cultural representation. Furthermore, this REAP was able to distinguish between visitor and resident values, which on this site were in conflict. One aspect of the methodology, however, that needs to be expanded for use in the conservation field would be more emphasis on the needs of the visitor as well as of the local community residents.

### **Ellis Island Access Alternatives: Conflicting Cultural Values**

The research goal was to provide commentary from an ethnographic perspective on four possible scenarios—a bridge, subsidized ferry, elevated rail, and tunnel. For the purposes of this project, the culturally appropriate populations included the local users of Battery Park and Liberty State Park; local providers of services at Battery Park and Liberty State Park, including vendors and small-scale tourist services; residents of the Jersey City neighborhoods adjacent to Liberty State Park; special populations such as children, the elderly, and the physically challenged; and “traditional cultural groups”—those people whose families entered through Ellis Island or who are themselves immigrants with identities and aspirations symbolically connected to Ellis Island.

Ellis Island in New York was the principal federal immigration station in the United States from 1892 to 1954. More than twelve million immigrants were processed there, and it is estimated that over 40 percent of all U.S. citizens can trace their ancestry to those who came through the Registry Room. In 1954, Ellis Island closed and was virtually abandoned until 1965, when President Lyndon Johnson added it to the Statue of Liberty National Monument under the jurisdiction of the NPS. The restoration of Ellis Island began in 1983, and the Ellis Island Immigration Museum opened in 1990, with the building being restored to the period of 1918–20.

Visitors to the Ellis Island Immigration Museum mostly arrive by ferries that leave from Battery Park in New York City and make stops at the Statue of Liberty and then at Ellis Island before returning to Battery Park. There is also an infrequent ferry from Liberty State Park in New Jersey. The cost of the ferry trip was \$6.50–\$7.00 at the time of this study. People who work on Ellis Island, however, especially construction workers with trucks and materials, drive across a temporary bridge built to enable the earlier historic preservation work; the bridge spans the four hundred meters from Liberty State Park in New Jersey to Ellis Island. Senator Lautenberg of New Jersey was able to appropriate close to \$15 million of the federal budget to build a permanent bridge to replace the existing structure. The proposed bridge would have allowed both vehicular and pedestrian traffic.

This study was begun in the summer of 1994 and was undertaken as part of the environmental impact statement required under federal law to disclose and evaluate the impact of building and operating the proposed bridge. Much of the concern focused on whether making Ellis Island accessible by footbridge would compromise the island’s historical integrity. The task was to evaluate the impact of a bridge on the sociocultural environment of the two places from which the existing passenger ferry service departs for Ellis Island—Liberty State Park in Jersey City and Battery Park in New York—and to consider the impact on nearby Jersey City neighborhoods. The author was also asked to find out whether the research participants were in favor of the bridge or not. The bridge was later taken out of the federal budget, and the project was dropped. The “temporary” bridge remains in service to authorized vehicles and personnel.

### **BATTERY PARK**

Battery Park is one of approximately fifteen hundred parks, playgrounds, and other public spaces under the jurisdiction of the City of New York’s Department of Parks and Recreation. The park covers almost twenty-three (22.98) acres of land in a tear-shaped form that stretches among State Street, Battery Place, and the New York harbor. The ferry to the Statue of Liberty and Ellis Island leaves from the end of the park. On any summer day, the park is filled with tourists waiting in line for the ferry.

Visitors to the park consist of various categories of tourists, the Wall Street lunchtime crowd, and New York and New Jersey residents who come to enjoy the park. Tourists can be found throughout the park, although

the majority tend to convene near the ferry landing, souvenir pushcart area, and tour bus area. Lunchtime workers tend to sit both in the sun and in the shade of Eisenhower Mall, around the great lawn, and in the picnic areas. Fishermen tend to gather at the end of the harbor. Bikers and rollerbladers use the length of the promenade. Sunbathers can be found along the edges of the promenade where there is the least shade.

Several different groups of park and recreation authorities serve Battery Park. NPS rangers are generally inside or at the door of Castle Clinton, directing tourists or giving guided tours in the parks and surrounding neighborhood. City Parks and Recreation employees work throughout, maintaining the park. Several city employees regularly lunch in the playground area at the picnic tables. A police car patrols the park for security, and often city park officers are seen talking with homeless individuals or illegal street vendors.

There are many kinds of vendors in Battery Park. Three pushcart vending companies—two that concentrate on food and one that sells souvenirs—have pushcarts regularly in the park. One of these vending companies also owns both outdoor restaurants. This company has only four carts, which are within the vicinity of the east-side outdoor restaurant. Another pushcart company employs the majority of immigrants operating pushcarts near the entrance to the park, Castle Clinton, and the nearby tourist bus stop. The third company occupies territory near the tour-bus stop, as well as near the ferry landing. Independent vendors are spread out between the two ends of the park.

Street performers position themselves on the promenade where boat lines are formed, along the wide path to the great lawn, at the crossroads in front of the great lawn, or between the Castle and the promenade. A large number of homeless people reside in the park. The stone slabs of the war memorial offer privacy to a person sleeping on a bench. Patches of healthy grass, bathrooms, and a running fountain in the park are resources to the homeless residents. By evening, the homeless residents outnumber other park users. A service center for homeless individuals is located underneath the Staten Island terminal, and a soup kitchen is located in the surrounding neighborhood.

#### LIBERTY STATE PARK

Liberty State Park occupies 1,122 acres of land and tideland along Upper New York Bay in Jersey City, New Jersey. The site was a vast railroad yard throughout most of the

twentieth century. By the 1960s, all passenger rail and freight operations on the site had been abandoned. The State of New Jersey acquired the site and has been gradually transforming it into a public park. The first phase of Liberty State Park opened in June 1976, in time for the national bicentennial observances. The area developed for park use so far comprises approximately three hundred acres, mostly at the southern and northern edges of the park.

The southern area—which was the first part of the park to be constructed and opened and is the most intensively used area in Liberty State Park—includes grass-covered fields, a public boat launch, walkways along the waterfront, spacious parking lots, and the park headquarters, which contains a food concession stand, restrooms, and visitor information. The northern area has three centers of activity widely separated by flat, mostly treeless fields. Two of the activity centers are major developments of recent years: the Liberty Science Center and the restored head house and concourse of the Central Railroad of New Jersey (CCRNJ) ferry terminal, where passengers once boarded ferries for New York.

The third concentration of activity in the northern area is the Statue of Liberty and Ellis Island passenger ferry dock, which is located along the Tidewater Basin. Visitors to the two national monuments can park in the newly constructed parking lot across Johnston Avenue, west of the CCRNJ terminal train shed, and walk across the street to the ferry dock, from which the ferries come and go at roughly forty-five-minute intervals. Next to the dock are a ticket stand operated by the ferry company, a film and souvenir stand, several picnic tables, sheltered waiting areas, several refreshment vendor carts, and public lavatories.

The most popular area includes the perimeter walkways around the Liberation Monument, east of park headquarters, and the section of Liberty Walk that continues from this field on a trestle across the south cove. This area is within easy walking distance of two large parking lots and offers spectacular views of the bay, the Statue of Liberty, and the New York skyline. Liberty Walk itself has numerous benches where people rest and enjoy the views and the breezes.

The picnic grove is used by families, organized groups, and some individuals alone. People can buy take-out food at the stand in the park headquarters, but most seem to bring picnics, and some cook on outdoor grills. The stretches of Liberty Walk that bridge the north and south coves are popular with people who fish, especially in

the early morning and in the evening—times when the fish are feeding.

The brick plaza next to the CCRNJ Terminal is used occasionally in the daytime for ceremonies, such as Flag Day observances by the Jersey City Fire Department. In summer, Jersey City sponsors Sunday afternoon jazz concerts here. On sunny evenings, people may drive down to the plaza, parking in the free lot next to the ferry terminal, to watch the sunset. The CCRNJ Terminal is lightly used on weekdays by people visiting the historical exhibits in the old waiting room, using the lavatories, or just looking at the building itself. On some weekends the terminal is used for special events like ethnic festivals or collectors' shows, which may attract thousands of people.

#### NEARBY JERSEY CITY NEIGHBORHOODS

Three neighborhoods bordering Liberty State Park were selected for study: (1) Paulus Hook, a small gentrified area of brownstone row houses and corner parks; (2) Van Vorst, a larger area of elegant brick and brownstone row houses focused on Van Vorst Park, a residential square, with some gentrification amid a highly heterogeneous population; and (3) Lafayette, a mixed industrial and low-income residential area of tenements, wooden row houses, public housing projects, and newer, subsidized modular housing. These neighborhoods were selected both for their proximity to Liberty State Park and because they are representative of the social diversity of Jersey City.

Paulus Hook is a historic, peninsular neighborhood, across the Tidewater Basin from Liberty State Park. It is bounded by Hudson Street on the east, York Street on the north, Marin Boulevard on the west, and the Tidewater Basin on the south. The Morris Canal Little Basin, on the southeastern edge of Paulus Hook, is the last vestige in Jersey City of the early-nineteenth-century Morris Canal, a shipping channel that crossed the state of New Jersey to connect the two great rivers of the Mid-Atlantic region: the North River (the Hudson) and the South River (the Delaware). The clearance of industrial buildings from the lot between Hudson Street and the Hudson River has opened up beautiful views of the river, the harbor, and the skyscrapers of downtown New York. The open lot is currently used for public parking. The enormous Colgate toothpaste electric sign, the face of its clock big enough to be read from Manhattan, has been relocated from the former Colgate factory nearby to a site at the river's edge, just east of the open lot. A new weekday passenger ferry service operates between the newly named Colgate Pier,

next to the sign, and the World Financial Center ferry dock in New York.

The center of the neighborhood is made up of three corner parks across from one another, where people sit on benches in the shade during hot summer afternoons. The park users are representative of the various residents of the neighborhood: some are Polish-speaking immigrants who are longtime residents of the area, some are Spanish-speaking recent immigrants, and a few are older English-speaking European Americans. The gentrified center of the community is Washington Street, a mixed residential and commercial street, with an expensive Italian restaurant across from law and real estate offices. There are a number of churches in Paulus Hook, including Eastern Orthodox, Roman Catholic, and a Polish Roman Catholic church, Our Lady of Czestochowa. Each of these churches offers numerous community activities and services, including senior centers, parochial schools, and summer children's programs.

Van Vorst is bounded by Grand Street on the south and by Monmouth and Brunswick Streets on the west. The streets surrounding the park, including York, Mercer, Montgomery, Monmouth, Varick, and Barrow Streets, are lined with substantial row houses of brick and brownstone dating from the middle and late nineteenth century. The largest and most splendid houses look out on Van Vorst Park from Jersey Avenue. Gentrification has been under way in Van Vorst since at least the mid-1970s. Many houses in the neighborhood have been refurbished and their architectural details restored. On the same streets, salsa music can be overheard from double-parked cars of residents who have stopped to talk to a friend at the local bodega or to someone sitting on a row house stoop. Many of these conversations are in a mixture of English and Spanish. Further down the street, elderly African-American residents sit or stand on their stoops conversing with neighbors who are returning home or passing by on the way to the busy bodega. Van Vorst has a number of churches, including various Spanish-speaking congregations of local evangelical churches.

Lafayette is located along the western edge of Liberty State Park. It is a residential neighborhood with many intrusions of car repair shops, scrap metal yards, and piles of old tires and other industrial waste. Part of the neighborhood has small manufacturing shops side by side with residential streets. Most of the community members interviewed were African Americans or Spanish-speaking Caribbean Americans who had lived in the neighborhood for some time. Families live in brick or



stone row houses, in larger apartment projects, or in the new, subsidized modular attached town houses. The center of the Lafayette African-American male community is the barber shop, where men sit, talk, and exchange news throughout the day. The bodegas and bus stops on each corner of Pacific Street also provide opportunities for conversations and neighborly interchange, particularly for women, younger men, and mothers with young children. The major school in the area is the Assumption–All Saints parochial school, run by Sister Maeve McDermott. According to Sister Maeve, she is responsible for 750 children in this relatively poor area. The Convent of the Sisters of Charity has been a mainstay in the community for over eighty years and runs the school and summer programs for local children. There are a number of other churches throughout the neighborhood, including the Monumental Baptist Church, where the researchers interviewed a number of the congregation, and the African Methodist Episcopal Church, as well as other small evangelical and storefront congregations.

**RELEVANT FINDINGS: INTERESTS AND ATTITUDES**

The research focused on constituency groups; further into the project, however, when constituency analysis did not provide statistically significant clustering of similar people and points of view, a values-orientation-based analysis was incorporated. The constituency groups provided a guide to sampling the users and residents on the three sites—Battery Park, Liberty State Park, and the Jersey City neighborhoods surrounding Liberty State Park (Paulus Hook, Van Vorst, and Lafayette)—who were consulted concerning their perceptions of possible positive or negative impacts of each of the proposed access alternatives. Their attitudes and concerns were collected through a series of REAP data collection methods—including behavioral maps, transect walks, individual interviews, expert interviews, impromptu group interviews, and focus groups—completed at the various field sites (see Table 5). A total of 318 people were consulted: 117 through individual interviews in the two parks, 113 through impromptu group interviews in neighborhood gathering places, and 88 in focus groups both in the parks and in neighborhood churches and institutions.

*Table 5 REAP methodology for Ellis Island access alternative project.*

Method	Data	Duration (days)	Product	What Can Be Learned
Physical traces mapping	Map of trash and clothing left at site	1	Description of physical condition of site	Identifies nighttime activities that would be affected by the proposed bridge and alternatives
Behavioral mapping	Time/space maps of site, field notes	2	Description of daily activities at site	Identifies daily activities that would be affected by the proposed bridge and alternatives
Transect walks	Transcribed interviews and consultants' maps of site, field notes	4	Description of site from community member's point of view	Community-centered understanding of the site; local meanings
Individual interviews	Interview sheets, field notes	10	Description of responses of the constituency groups	Community and user responses to the proposed bridge and alternatives
Expert interviews	In-depth interview transcriptions	5	Description of positions of local institutions and community leaders	Community leaders' responses to the proposed bridge and alternatives
Group interviews	Field notes, video or tape recording	5	Description of various community groups and their responses to the proposed bridge and alternatives	Involves the neighborhood and church groups in the planning process; provides for public discussion of issues in the local context
Focus groups	Field notes, video, or tape recording	2	Description of issues that merge in small group discussion	Enables the development of a typology of responses and in-depth discussion of alternatives

The data were analyzed by coding all responses from the interviews and focus groups and then by comparing constituency groups. Constituency groups were defined as groups of people who share cultural beliefs and values and who are likely to be affected by the proposed access alternatives in a similar way. Correlational, content, and value orientation analyses were utilized to present the various positions held by consultants across the subgroups studied in this project.

In addition to the coding of all responses from the interviews and the analysis by constituency, correlational analyses were applied where possible. The attitudes toward the alternatives were analyzed for content and presented as lists of arguments for and against the bridge and the other alternatives. Finally, a value orientation analysis summarized the various positions held by consultants across the subgroups studied in this project.

In Battery Park, the people the most concerned about the negative impact of a bridge were the service managers, city employees, park employees, ferry representatives, and tour bus drivers—that is, those constituencies with a vested interest in the success and profitability of Battery Park. The greatest differences in attitudes about the proposed bridge were found between people who were recreating, versus those who were working, in Battery Park—recreating consultants were more positive, and workers were more negative—and between people who were immigrants and those who were native born—immigrants were more positive, and the native born were more negative. Overall, Battery Park users were most concerned about the economic consequences of the proposed access alternatives, but there were a number of people who were concerned about access to Ellis Island or who questioned the social priorities of the bridge alternative.

In Liberty State Park, constituency groups were not predictive of attitudes toward the alternatives, with the one notable exception of such vested interests as Liberty State Park officials and workers, who were overwhelmingly against the proposed bridge. The active recreation users, such as walkers and cyclists, were more in favor of the bridge than were the passive user groups and organized group leaders. There was also a sharp distinction between Latino and non-Latino consultants: the Latino consultants were very positive about the access alternatives, as compared with non-Latino groups. The same differences in attitude between user type (work-related use versus recreational use) and place of origin (immigrant versus native born) found in Battery

Park were found in Liberty State Park. The two most frequently cited value orientations were health and recreation, and park quality—quite a contrast from the economic findings in Battery Park—followed by aesthetic concerns and concerns about improved access.

The residents of the various neighborhoods surrounding Liberty State Park were generally in favor of the proposed bridge and less interested in the other alternatives, yet each neighborhood had a slightly different perspective on the issue. Paulus Hook residents had very mixed opinions about the proposed bridge and were concerned about potential problems, such as increased traffic or limited parking, that might occur. Van Vorst residents were more positive and considered the proposed bridge a way to increase democratic access to Ellis Island. They saw the recreational benefits of the bridge as an improvement to their neighborhood. Lafayette residents were the most positive about the proposed bridge because it would allow them to visit Ellis Island without paying the ferry fare, which was perceived as too high for families and groups of children to afford in this low-income area. They, too, saw the bridge as an amenity that would add to the beauty and recreational potential of Liberty State Park and their local community.

#### RELEVANT FINDINGS: VALUE ORIENTATIONS

Table 6 presents the value orientations compared across the parks and neighborhoods. What is clear from this comparison is that each area has slightly different priorities and concerns. Battery Park workers and users are not at all concerned with the cost of the ferry or the bridge but instead are concerned about the possible economic consequences of the proposed access alternatives. Liberty State Park workers and users, on the other hand, are concerned with the health and recreation advantages and park-quality disadvantages of the access alternatives. The residents of Paulus Hook, Van Vorst, and Lafayette are most concerned with the cost of the ferry or proposed access alternative. Cost, access, park quality, and economics were the most frequently mentioned concerns for all groups. Table 6 is useful in understanding the variation among these populations and can be used to judge how often a concern was expressed by consultants in this study.

One important conclusion from Ellis Island is that all the people the researchers talked to were interested in the questions asked and were quite sophisticated in their understanding of the problem and its consequences, regardless of cultural or educational background. Thus, concerns that the general public would not be able to evaluate the access alternatives or would not care about the proposed changes to Ellis Island and Liberty State Park were unfounded. This finding suggests that values assessments and planning processes can be enhanced by consultation with local populations through the REAP process.

## **Integrating Anthropological-Ethnographic Methods into Heritage Conservation Planning and Practice**

Table 7 outlines a research approach to heritage conservation planning that includes constituency analysis, ethno-semantic methodologies, and REAPS, as strategies in a values assessment process. Although these are not the only strategies for assessing relevant cultural values, they are an excellent place to start. A Getty Conservation Institute report, from the “Economics and Heritage Conservation” meeting of 1998, which was focused on the economics of value assessment, also proposes a number of other strategies for overlaying and assessing heritage, once the values are identified (GCI 1999).

A final question about who should be undertaking these various projects does not have a simple answer. The overall project—including the identification of stakeholders, the development of a values typology, the values assessment process, the evaluation and ranking of values, and a follow-up with more detailed assessment as necessary—should be organized and directed by the conservation professional. But values assessment, particularly when a REAP is used, is a team process.

Experienced ethnographers and field workers will be able to produce the necessary data more quickly and easily than other professionals. Furthermore, the analysis process requires considerable training and background in qualitative analysis techniques. Yet the techniques involved in constituency analysis, ethnosemantic methodologies, and REAPS can be learned through a series of training workshops. Local participants can become excellent on-site field workers, and the REAP process usually includes local collaborators. In fact, part of the point of undertaking a REAP is to create connections to the local community.

The best situation, if finances allow, is to bring together a team made up of conservation professional(s), ethnographer(s) (the number depends on language demands), and two to three local residents and/or experts who would like to be part of the values assessment process. The residents and experts can be trained by the ethnographers to assist in interviewing and mapping, while the ethnographers would undertake the group interviews, focus groups, and participant observation. There are many combinations of expertise that are useful, and these would have to be developed for each project on site.

**Table 6** Value orientations by site in Ellis Island access alternative project.

Value Orientation	Battery Park	Liberty State Park	Surrounding Neighborhoods	Total
Cost	0	7	35	42
Access	13	8	20	41
Park quality	6	11	20	37
Economic	23	7	6	36
Health and recreation	9	11	9	29
Choice	9	7	5	21
Aesthetic	6	8	6	20
Social priorities	10	7	2	19
Political	8	5	3	16
Education	4	3	8	15
Personal	8	3	1	12
Safety and comfort	4	5	3	12
New technology	5	5	0	10
Ecological	2	3	4	9
Not going to have impact	9	0	0	9
Community quality	0	0	7	7

Table 7 Cultural values assessment procedure.

Task	Methodology	Specific Techniques
Identify stakeholders	Constituency analysis	Expert interviews, behavioral mapping, physical traces mapping, participant observation
Develop values typology	Ethnosemantic methodology	Work with panel of representatives from each constituency to evaluate values typology, translate values typology into local categories
Values assessment	REAP	Individual interviews, transect walks, focus groups, participant observation
Overlay values assessments	Ecological planning and design process	Constituency groups are represented in a process that assesses values and negotiates ranking of values priorities/importance
Discuss assessments with stakeholders	REAP	Focus groups, impromptu interviews, group interview
Repeat procedure for more detailed assessments of individual values where conflicts arise	Constituency conflict analysis	Individual interviews, behavioral mapping, expert interviews

## Conclusion

This paper has outlined how qualitative anthropological-ethnographic methods can be incorporated into the process of value assessment at heritage sites. The proposed methodologies are intended to be complementary to a parallel economic values assessment that utilizes the techniques identified in the *Economics and Heritage Conservation* meeting report (GCI 1999). The next step in developing an integrated “sociocultural-economic” model of valuing the significance of a historic site requires field testing with clients or stakeholders and local community groups, as well as field testing that addresses values conflicts. When this proposed methodology is applied in a real-life case study, problems and redundancies in the assessment process will become apparent. After this test application, the conclusions of this paper should be revisited, discussed, and evaluated, and a final model methodology should be proposed.

## Notes

1. Adapted from Low (1981).
2. Portions of the literature review are based on the more extensive discussion found in Taplin, Scheld, and Low (forthcoming).

## References

- Bean, L. J., and S. B. Vane. 1987. Ethnography and the NPS: Opportunities and obligations. *CRM Bulletin* 10(1):36–40.
- Beebe, J. 1995. Basic concepts and techniques of rapid appraisal. *Human Organization* 54:42–51.
- Brugge, D. M. 1987. Cultural use and meaning of artifacts. *CRM Bulletin* 10(1):4–16.
- Crespi, M. 1987. Ethnography and the NPS: A growing partnership. *CRM Bulletin* 10(1):1–4.
- Ervin, A. M. 1997. Trying the impossible: Relatively “rapid” methods in a city-wide needs assessment. *Human Organization* 56:379–87.
- Getty Conservation Institute (GCI). 1999. *Economics and Heritage Conservation: A Meeting Organized by the Getty Conservation Institute, December 1998*, ed. R. Mason. Los Angeles: Getty Conservation Institute.
- Joseph, R. 1997. Cranberry bogs to parks: Ethnography and women’s history. *CRM Bulletin* 20:20–24.
- Kent, S. 1984. *Analyzing Activity Areas: An Ethnoarchaeological Study of the Use of Space*. Albuquerque: University of New Mexico Press.
- Liebow, E. 1987. Social impact assessment. *CRM Bulletin* 10(1):23–26.

- Low, S. M. 1981. Social science methods in landscape architecture. *Landscape Planning* 8:137–48.
- . 1982. Professional culture: The boundary between theory and practice in design. *Resources in Education*, ERIC Report 219290:2–19.
- . 1987a. A cultural landscapes mandate for action. *CRM Bulletin* 10(1):30–33.
- . 1987b. Developments in research design, data collection, and analysis: Qualitative methods. In *Advances in Environment, Behavior, and Design*, vol. 1, ed. E. N. Zube and R. T. Moore. New York: Plenum Publishing, 279–303.
- . 2000a. Culture, politics, and the plaza: An ethnographic approach to the study of urban public spaces in Latin America. In *Culture-Meaning-Architecture*, ed. K. D. Moore, 233–46. Aldershot: Ashgate.
- . 2000b. *On the plaza: The politics of public space and culture*. Austin: University of Texas Press.
- Low, S. M., and W. Ryan. 1985. Noticing without looking: A methodology for the integration of architectural and local perceptions in Oley, Pennsylvania. *Journal of Architectural Planning and Research* 2:3–22.
- Low, S. M., et al. Forthcoming. Recapturing erased histories: Ethnicity, design, and cultural representation. *Journal of Architectural and Planning Research*.
- National Park Service (NPS). 2000. Applied ethnography program. NPS Web site (<http://www.cr.nps.gov/aad/appeth.htm>).
- Pavrides, E., and J. E. Hesser. 1989. Vernacular architecture as an expression of its social context in Eressos, Greece. In *Housing, Culture, and Design: A Comparative Perspective*, ed. S. M. Low and E. Chambers, 357–74. Philadelphia: University of Pennsylvania Press.
- Rapoport, A. 1982. *The Meaning of the Built Environment*. Beverly Hills, Calif.: Sage Publications.
- Richardson, M. 1984. Place: Experience and symbol. *Geoscience and Man* 24:1–3, 63–67.
- Taplin, D., S. Scheld, and S. Low. Forthcoming. REAP in urban parks: A case study of Independence National Historical Park. *Human Organization*.
- Whyte, W. H. 1980. *The Social Life of Small Urban Spaces*. Washington, D.C.: Conservation Foundation.
- Wolf, J. C. 1987. Martin Luther King Jr. *CRM Bulletin* 10(1):12–13.



# Economic Valuation of Cultural Heritage: Evidence and Prospects

By Susana Mourato and Massimiliano Mazzanti

IN RECENT YEARS, THE DEMAND for cultural destinations has become a major force in the global economy (Grefe 1990, 1999; Pearce and Mourato 1998). Tourist trips typically include cultural heritage elements that range widely, from a journey to a historical town center to a visit to a museum or a stroll around a historic garden. Visitors benefit from the expectations, experiences (educational, visual, recreational), and memories offered by heritage assets; while nonvisitors may benefit indirectly through magazines, films, or, increasingly, the Internet (virtual visits). Even if one does not use a cultural asset at present, investing in its conservation and maintenance retains the possibility of being able to use it at some point in the future. This *option value* of cultural destinations is akin to an insurance premium.

Furthermore, people may attach a value to the conservation of cultural resources for a number of reasons—without ever using or visiting them. There may be altruistic feelings associated with the knowledge that other people may enjoy cultural heritage. Or there may be bequest motivations accruing from the desire to conserve cultural goods for future generations. Or there may even be existence values—that is, benefits that come from the knowledge that cultural heritage is being conserved for its own sake. These *nonuse values* are thought to be a significant proportion of the *total economic value* of cultural heritage, which may well extend beyond country borders.

Yet despite its obvious benefits to society, cultural heritage is increasingly threatened with degradation and destruction. While some risk factors result from natural environmental causes (such as earthquakes, landslides, volcanism, floods, avalanches, and coastal dynamics), human activities are arguably the main pressures behind the decay and loss of cultural assets. These include tourist and user pressure, unplanned urbanization, destructive development projects, theft, vandalism, war, air pollution, vibration, and plain neglect.

Part of the problem is that many cultural assets are not traded in markets: they have a “zero price” and can be enjoyed by many without charge. In other words, these so-called nonmarket cultural resources are valued by soci-

ety but in a way that is not translated into any market price—i.e., they are external to markets. The impacts on conservation of this “market failure” can be severe: underfunding, with insufficient funds generated to finance conservation; strong reliance on government support and public subsidy, which leaves the conservation of many important cultural assets at the mercy of political whims and overstretched government budgets; overuse, with resulting wear and tear, congestion, vandalism, and theft; and inability to compete on the same level with alternative development projects, as the economic value of cultural assets appears to be zero or very small. A notorious example is the recent loss of the ancient city of Zeugma in Turkey, which was flooded because of the construction of a dam. The discovery on site of some of the most beautiful Roman mosaics in the Near East did not prevent the complete destruction of the city remains.

Paradoxically, underuse of cultural resources can also be detrimental for conservation. This is the case, for instance, when the goal of preserving a site is pursued by implementing only defensive policies, such as listing, without investment in integrated strategies of valorization: conservation, restoration, and demand-oriented policies.

Even when cultural goods and services are marketed, like many cultural destinations where visitors are required to pay an entry fee, more often than not there is a failure to practice optimal charges—namely, fees that would maximize visitor revenues without compromising targets for number of visits and fees that could subsequently revert to conservation (Steiner 1997; Hett and Mourato 2000; Beltran and Rojas 1996). For example, in the case of the Historical Sanctuary of Machu Picchu in Peru, where both foreign and national tourists are charged the same, Hett and Mourato estimate that 80 percent of all visitors would be willing to pay higher fees (Hett and Mourato 2000). A policy of price differentiation between foreign and national tourists was found to increase the profitability of the site by more than 150 percent while simultaneously increasing visitation rates of national visitors by about 15 percent.

Statements in the existing cultural heritage literature that attempt to motivate conservation policies by reference to large “cultural values” are commonplace (Feldstein 1991; Couper 1996; Hutchinson 1996), and the deterioration or disappearance of any item of this heritage is thought to constitute a harmful impoverishment of the world heritage of mankind as a whole (UNESCO 1972). However, apart from what can be inferred from data on visitors and from maintenance and restoration expenditures, little is known about the actual magnitude of the economic value of nonmarket cultural resources. Even less is known about how changes in quality affect the value of these resources. Somewhat surprisingly, there has been little effort to demonstrate these values in practice.

But there is some good news. In the last two decades, economists have developed techniques to assess the economic value of changes that are external to markets. In recent years, a number of these nonmarket valuation methods have gained increasing popularity among academics and policy makers, particularly since a panel of experts led by two Nobel laureates in economics ruled that, under certain conditions, they were reliable enough to be used in a U.S. court of law in the context of natural resource damage assessment (Arrow et al. 1993). Following this historic decision, survey methods like contingent valuation (Mitchell and Carson 1989) have flourished and have been widely used in environmental decision making at various levels (Bateman et al. 2002). A contingent valuation questionnaire is a survey instrument that sets out a number of questions to elicit, among other information, the monetary value of a change in a public good or service. Most interestingly, its use has slowly but inexorably extended into other fields, such as health, transport, social, and, notably, cultural policy.<sup>1</sup>

The estimation of the economic value of cultural heritage conservation has increasingly been recognized as a fundamental part of cultural policy (Frey 2000; Throsby 2001; Maddison and Mourato 2002; Creigh-Tyte, Dawe, and Stock 2000; Darnell 1998; Navrud and Ready 2002; Nuti 1998; Pearce and Mourato 1998; Davies 1994). Empirically, there are at least two powerful arguments for using economic valuation to inform macro and micro decisions in the cultural heritage sector. On the one hand, public institutions are increasingly being required to justify their expenditure decisions or requests for funding in terms of generated “consumer benefits,” and those that are unable to do so might find their budgets cut. Furthermore, in a

world where potential visitors are spoiled for choice, time constrained (rather than income constrained), and getting more sophisticated, cultural destinations are having to renew and market themselves to compete and survive. A consumer-oriented approach has increasingly taken over traditional supply-driven approaches to cultural heritage management and conservation, leading to ongoing market research studies to understand demand, strong marketing to generate awareness and attract new visitors, and a focus on building “brand” loyalty and encouraging repeat visits, essential for long-term survival. For these reasons, discussed in more detail in the following sections, demand-led approaches, such as economic valuation techniques, might quickly form an integral part of the new lexicon of the cultural industry and a useful component of the cultural analyst tool kit. Economic value as defined here does not deny the importance of other value dimensions but has a specific, and arguably special, role to play in cultural policy toward heritage fruition, enhancement, and conservation.<sup>2</sup>

In essence, neglecting to take into account the economic value of cultural heritage conservation and the full costs and benefits of policies, regulations, and projects with cultural components can lead to suboptimal allocation of resources in the sector, investment failure, and continuous degradation of the world’s cultural assets. Clearly, these are complex issues that need to go beyond the financial aspects and be understood in the wider context of raising adequate financing for conservation and renewal, while, at the same time, reaching out and encouraging a demand to visit and appreciate cultural heritage. This paper argues that economic valuation is a necessary (although not sufficient) stage to achieve the sustainable use of cultural resources and to help reach a balanced, optimal mix of preservation, conservation, and access, while assessing the relative opportunity costs of each component.

The rest of the paper is organized as follows: The next section, “Economic Valuation: Principles and Tools,” presents the basic principles of economic valuation and examines a range of economic tools for the evaluation of cultural heritage, explaining their advantages and disadvantages. In the following section, the authors discuss the role of economic valuation techniques for microanalysis of cultural policies and cultural institutions and argue the need for measuring (nonmarket) economic flows to inform cultural policy and management; some cultural targets that economic valuation tools might help to achieve are also suggested. The following section reviews



the current evidence on the application of economic valuation methods to cultural goods and discusses its main findings and implications. The final section proposes a new framework for the valuation of cultural heritage, based on recent developments of economic measurement tools and on a more integrated approach for socio-economic-cultural evaluation. Conclusions and suggestions for future research are also presented.

---

## **Economic Valuation: Principles and Tools**

### **Basic Principles**

In line with standard economic theory, human well-being is determined by people's preferences. A benefit is defined as anything that increases human well-being, and a cost as anything that decreases human well-being. Measurement of preferences is obtained by finding out individuals' maximum willingness to pay (WTP) for a benefit or for the avoidance of a cost, or their minimum willingness to accept (WTA) compensation for tolerating a cost or forgoing a benefit. The rate at which individuals are prepared to trade off goods and services against one another corresponds to the total economic value of a change in the price or quality of a good or service.<sup>3</sup> This is because it forces people to take into account the fact that they are being asked to sacrifice some of their limited income to secure the change and must thus weigh the value of what is being offered to them against alternative uses of that income. In this sense, WTP is a much more powerful measure of value than an attitudinal statement. While people may say, in response to an attitudinal question, that they "care about" many things, in practice they will only be able to pay for a much smaller subset of these things.

WTP is normally expressed in the marketplace. The market equilibrium between demand and supply of goods and services is a reflection of people's preferences and is characterized by an optimal quantity and price. Consumers who are willing to pay the market price of a good or service will buy it: for those willing to pay exactly the market price and no more, the cost of buying the good or service—i.e., the money they spend—is just equal to the benefit they get from the purchase—i.e., the well-being generated by the good; while those consumers who are willing to pay more than the price will also buy that good and get a net gain from the purchase, a "consumer surplus," measured by the excess of WTP over price. When the price of the good exceeds the price that people are pre-

pared to pay for it, there is no corresponding welfare loss, as people simply do not buy that good.

A large proportion of cultural goods and services are traded in markets: cultural tourism, performing arts, antiques, paintings, and books are just a few examples of cultural goods for which thriving markets exist. But even in these cases, pricing policies are many times controlled, noncompetitive, and arbitrary, and price discrimination is not effectively implemented (see Hett and Mourato 2000 or Beltran and Rojas 1996 for examples). Further, many market imperfections are present, such as the monopoly power of institutions and government subsidies, which prevent competitive pricing.

But of specific interest to this paper are the many cultural goods and services that are not traded in the market and that hence do not have a price. This is due to some of the special characteristics of cultural heritage, related to its property rights and type of use, that prevent the existence of the necessary markets for individuals to express their preferences. Using economic terminology, many cultural assets are *nonrival* and *nonexclusive* in consumption; in other words, the fact that one individual enjoys an asset does not prevent others from enjoying it as well, and no one can be excluded from its enjoyment (i.e., open access or common property). Assets with these characteristics are called public goods and are typically provided for collectively by governments and paid for through taxes. A historical town center is a good example of a public good: it is open-access, and large numbers of visitors can enjoy it simultaneously. A similar case occurs when a cultural good has external effects (externalities) that are not captured by the market. For example, conservation works carried out on a historical building may have a positive visual externality for passers-by. This external effect is not captured in any market (pecuniary) transaction.

As noted previously, these situations where the market does not reflect the full welfare provided by the good are called market failures, and they typically occur with assets, such as cultural heritage, that have public-good characteristics. Market failure can result in underpricing and overuse and lead to "free riding"—a situation in which people can enjoy the benefits of the cultural asset without having to pay for them. Going back to the previous example, people may derive utility from viewing the facade of a building without having to pay for it. Market failure provides a justification for government subsidy in support of culture, since commonly, the revenues collected from users are insufficient to cover conservation expenditure. Hence, cultural assets can become overly

dependent on (volatile) government subsidy. The inability of the market to reflect the full value of cultural goods also means that many destructive development projects are implemented on the grounds that they appear to generate higher financial benefits.

Evidently, the fact that many public cultural goods are not traded in markets does not mean that they do not have a value. The problem is how to measure that value, given the absence of a market. In the past, taking maintenance costs as a proxy of economic value has too often justified cultural heritage financing and management. But true WTP to prevent damage may be larger, smaller, or equal to maintenance or mitigation costs. This point is best illustrated through an example.

Suppose that a town council is interested in estimating the value of restoring and conserving a decaying ancient historical house, of notable architecture, where a famous musician lived for most of his life. Adopting the maintenance cost approach would mean that the costs of cleaning, repairing, and restoring the fabric of the building would be taken as a proxy for the value of its conservation. But this may seriously miscalculate the true economic value of cultural conservation. On the one hand, restoration and maintenance practices may not prevent damages to the structure of the house from occurring, and some practices may even cause additional injuries. As a result, a part of the total value of the property may be irreversibly lost when the original material is altered or replicated. Furthermore, the “cost” of maintaining the building may seriously underestimate the “benefits” to the public of conserving it, which extend beyond mere users of the building, as the property might be valued by many others for its historical significance and architectural beauty. Hence, existing figures on cultural property costs (say, per user, per area, or per year) should always be accompanied by and compared to similar and commensurable figures on benefits. Decisions should be based on a rigorous assessment of both benefits and costs and not solely on cost considerations.<sup>4</sup>

### Valuation Techniques

Recent developments in environmental economic theory and social survey methodology have made it theoretically defensible and practically feasible to value the economic benefits of several types of amenities not traded in markets, such as the benefits from accessing or conserving cultural resources. There is now an extensive literature on the methodologies for measuring the monetary values of

changes in nonmarket commodities, which is a major step beyond standard financial analysis that ignores many key values that affect well-being and behavior. The absence of markets is solved by the use of either stated-preference or revealed-preference techniques.<sup>5</sup> Table 1 gives a summary of the available methods applicable to the cultural heritage context.<sup>6</sup>

Table 1 Selected economic valuation methodologies.

Revealed Preferences	Stated Preferences
Hedonic price method	Contingent valuation method
Travel-cost method	Choice modeling
Maintenance-cost method	

**Revealed-preference methods** look at “surrogate markets”: they analyze preferences for nonmarket goods as implied by WTP behavior in an associated market. Popular revealed-preference techniques include the hedonic price method, the travel-cost method, and the maintenance-cost method. Although useful and theoretically sound (in the case of hedonic pricing and travel cost), the potential for their use in the estimation of the value attached to cultural sites is limited: revealed-preference methods cannot estimate option and nonuse values and cannot evaluate future marginal changes in cultural assets.

- The hedonic price method is based on the idea that house prices are affected by a house’s bundle of characteristics, which may include nonmarket cultural factors, such as historic zone designation (Rosen 1974). Other things being equal, the extra price commanded by a house in a historic area would be a measure of the WTP for historic zone designation. This method is of partial and limited use in the valuation of cultural heritage: it does not measure nonuse or option values and is only applicable to cultural heritage elements that are embodied in property prices. It also relies on the unrealistic assumptions of a freely functioning and efficient property market, where individuals have perfect information and mobility.

- The travel-cost method uses differences in travel costs of individuals making use of a cultural site to infer the value of the site (Clawson and Knetsch 1966). If different individuals incur different costs to visit different places, these “implicit” prices can be used instead of conventional market prices as the basis for estimating the value of cultural sites and changes in their quality. This method also has limited applicability: it can only estimate

visitor values for cultural heritage sites and is only useful for sites entailing significant travel. In addition, the valuation of multiattribute cultural sites and the presence of substitute locations present methodological problems.

- As was already mentioned above, the avoided-maintenance-cost approach has often been used to estimate damages to cultural materials (for example, from air pollution). The reason is that cost information is easier to collect than benefit information. The method consists of calculating the cost savings implied from a reduction in maintenance cycles due to reduced damage rates. However, as noted before, maintenance costs are not the correct measure of the benefits derived by society from reduced damage to cultural resources, and the sole consideration of costs may seriously underestimate true economic values.

In contrast with the group of techniques described above, stated-preference methods use “hypothetical markets,” described by means of a survey, to elicit preferences where there may be no surrogate market for a cultural good or service.<sup>7</sup>

The most popular stated-preference method is the contingent valuation (cv) method, which has been widely used in both developed and developing countries, particularly in the last decade, to determine the economic feasibility of public policies for the improvement of environmental quality. By means of an appropriately designed questionnaire, a hypothetical market is described where the good in question can be “traded” (Mitchell and Carson 1989; Bateman et al. 2002). This contingent market defines the good itself, the institutional context in which it would be provided, and the way it would be financed. A random sample of people is then directly asked to express their WTP (or WTA) for a hypothetical change in the level of provision of the good. Respondents are assumed to behave as though they were in a real market. In fact, cv questionnaires bear some resemblance to conventional market research for new or modified products.

As an illustration, in the context of cultural heritage, consider the following contingent scenario used in a cv study designed to estimate the benefits of keeping the Surrey History Centre, a local archive in the United Kingdom, open and running (adapted from Mourato et al. 2001). The cv scenario was preceded by questions about perceptions and attitudes toward recorded heritage conservation, use of the archive, and information about the archive’s services and resources. Both direct users and local nonusers of the archive were interviewed.

Please imagine the following situation. Priorities for public spending are changing in the United Kingdom. One of the sectors that will be negatively affected by government budgetary cuts is the libraries and archives sector that contains a great part of our recorded heritage. Due to this situation, unless additional resources are found, the Surrey History Centre might close down in 2001. As a result, all the resources contained in this archive will be lost as collections and may experience deterioration, or be dispersed (relocated to a number of other institutions) or be sold. Obviously some materials now contained in the Surrey History Centre may also be found elsewhere: but other materials and information are unique and might be therefore lost forever.

Now suppose that the council is considering charging every local household an annual council tax surcharge for an emergency grant to ensure that the Surrey History Centre does not close down, that the services it provides to the community can be maintained at their current levels, and that all scheduled investments will continue to go ahead. It was estimated that this would cost each household in the council £5 per year.

Please think about how much keeping the Surrey History Centre open is worth to you and your household. If it would cost each household only a small amount of money, then you might think that it was a price worth paying. On the other hand, if it was going to be very expensive, then you might prefer not to pay it and to have the archive close down.

Would you agree to pay an extra £5 per year in council taxes to prevent the closure of the Surrey History Centre and to ensure that its services are maintained at their current levels?

In the example above, a dichotomous choice elicitation question was used to uncover WTP. That is, respondents were simply asked whether they would be prepared to pay or not pay a particular amount of money. This amount was varied across subsamples—i.e., different people were asked to pay different amounts. There are many other ways of asking the WTP question, including simply asking respondents what their maximum WTP is (the open-ended format) or asking them to pick their maximum WTP amount from a list of money amounts (the payment card approach).

Theoretically, the cv method is based on welfare economics and assumes that stated WTP amounts are related to respondents’ underlying preferences. Furthermore, unlike revealed-preference techniques, cv is able to capture all types of benefits from a nonmarket good or service, including nonuse values. Neglecting the estima-

tion of nonuse values is potentially a serious omission, as many cultural goods arguably generate substantial nonuse benefits, possibly with transnational and intergenerational characteristics. As mentioned in the introduction, much of the impetus for the acceptance of the cv method was the report of the special panel appointed by the U.S. National Oceanic and Atmospheric Administration (NOAA) (Arrow et al. 1993). The NOAA panel concluded that cv studies could produce estimates reliable enough to be used in a judicial process of natural resource damage assessment including nonuse values.

While similarities exist between cv surveys and the type of surveys conducted in other disciplines (Boulier and Goldfarb 1998), cv questionnaires possess some distinguishing features that require special consideration. This is mainly for three reasons:

- cv questionnaires require respondents to consider how a possible change in a good or service that is typically not traded in markets might affect them.
- The type of public and mixed goods and services usually considered can be complex and unfamiliar to respondents.
- Respondents are asked to make a monetary evaluation of the change of interest.

All these aspects introduce a number of questionnaire design issues that do not occur in the case of opinion polls or marketing surveys for private goods. Mitchell and Carson note that “the principal challenge facing the designer of a cv study is to make the scenario sufficiently understandable, plausible, and meaningful to respondents so that they can and will give valid and reliable values despite their lack of experience with one or more of the scenario dimensions” (Mitchell and Carson 1989, 120).

The design of a cv questionnaire comprises three interrelated stages. The first and principal stage consists of identifying the good to be valued, constructing the valuation scenario, and eliciting the monetary values. In the second stage, questions on attitudes and opinions, knowledge, familiarity and use of the good, demographics, and various debriefing questions are added. The third stage consists of piloting the draft questionnaire for content, question wording, question format, and overall structure and layout. These stages are depicted in Table 2. For a detailed discussion, see that of Bateman and colleagues (Bateman et al. 2002).

Designing and implementing cv studies may seem to be a trivial task, where all that is required is to put together a number of questions about the subject of interest. But this apparent simplicity lies at the root of many badly designed surveys that elicit biased, inaccurate, and useless information, possibly at a great cost. In fact, even very simple questions require proper wording, format, content, placement, and organization if they are to elicit

Table 2 Stages of CV questionnaire design.

Stage	Description
Formulating the valuation problem	Identifying the policy change to be valued
	Writing a credible, meaningful, and understandable valuation scenario
	Choosing an elicitation format (open ended, payment card, dichotomous choice) and asking the wtp question
Selecting additional questions	Questions on attitudes, perceptions, and opinions
	Questions on knowledge and uses
	Debriefing questions (e.g., reasons for paying or not paying, credibility of scenario, etc.)
	Questions on socioeconomic characteristics
Pretesting the questionnaire	Focus groups
	One-to-one interviews
	Verbal protocols
	Field pilots

accurate information. Writing effective questionnaires in which scenarios and questions are uniformly and correctly understood by respondents and which encourage them to answer in a considered and truthful manner is no easy task (Mitchell and Carson 1989). To address these difficulties, a set of guidelines for applying cv to enhance the validity and reliability of estimates of nonuse values in natural resource damage assessment was developed by the NOAA panel (Arrow et al. 1993) and recently updated by Bateman and colleagues for the U.K. government (Bateman et al. 2002). Following these guidelines does not automatically warrant quality—neither does noncompliance necessarily indicate lack of validity. They are, however, a useful reference and the best available set of recommendations for practitioners in all fields.

In the context of the currently available valuation techniques, the cv method and its derivatives can arguably be considered the best available techniques to estimate the total economic value of cultural assets that are not usually traded in the market and where nonuse values are thought to be an important component of value.

### **Issues and Limitations**

But no method is without fault, and cv is no exception. As repeatedly pointed out by critics, a number of factors may systematically bias respondents' answers. Generally, these factors are not specific to cv as such but are common to most survey-based techniques and are predominantly attributable to survey design and implementation problems. Mitchell and Carson and Bateman and colleagues provide an extensive review of possible sources of bias (Mitchell and Carson 1989; Bateman et al. 2002). These include strategic behavior (such as free riding), embedding (where the valuation is insensitive to the scope of the good), anchoring bias (where the valuation depends on the first bid presented in a dichotomous choice context), information bias (when the framing of the question unduly influences the answer), or hypothetical bias (umbrella designation for problems arising from the hypothetical nature of the cv market).

Perhaps the most often quoted criticism of cv studies (and, indeed, of all survey-based research) is "Ask a hypothetical question and you will get a hypothetical answer" (Scott 1965). In addressing this issue, a useful approach is to examine what type of questions are likely to deliver useful information even when they are asked in regards to a hypothetical scenario. Carson, Groves, and Machina show that when respondents feel their response

may influence the actions of relevant agencies and when they care about the outcome of the valuation questions, they will answer according to their preferences, so as to maximize their expected well-being (Carson, Groves, and Machina 1999). In order to do so, they will respond to the incentives set out in the survey design: obviously, problems will occur when respondents feel that the survey market provides some incentive to do other than reveal their preferences truthfully. Unfortunately, there are a considerable number of possible situations in which truth telling might not seem the best way to maximize well-being. An example of relevance to cultural heritage studies is the use of charitable donations as a payment vehicle in WTP questions (as opposed to other mechanisms, such as taxes or entry fees). In this case, respondents have an incentive to overstate the WTP amounts in the survey to secure the provision of the good, and then, once the good is provided, they have an incentive to free ride when it comes to actually donating the amounts stated, as payment is voluntary.<sup>8</sup> Hence, one observes stated WTP amounts that are much higher than actual payments, a discrepancy that is not due to the hypothetical nature of the survey market but to the fact that respondents have been given the wrong incentives to reveal their true preferences. This is the issue of "incentive compatibility," and determining whether a given cv study design is incentive compatible is fundamental in order to avoid misrepresentation of values. In the example above, problems could potentially have been avoided by the use of a tax or an entry fee as the payment vehicle in the WTP questions, if at all possible.

Among the types of biases mentioned above, the problem of embedding is arguably the one that raises most concern for cultural valuation. Concerns regarding scope and embedding arise from "the frequent finding that WTP for a good is approximately the same for a more inclusive good" (Fisher 1996, 19). To illustrate, if respondents cannot meaningfully separate out the conservation value of one historic house from the value of all the historic houses in a region, then the validity of their responses has to be questioned. Careful design and pretest of questionnaires is needed to minimize the serious potential for embedding (Bateman et al. 2002). In particular, when scope problems are thought likely to arise (i.e., when one is interested in the benefits of conservation of some parts of a cultural site but not of others, or of some historical buildings in a city but not of others), tests can be built into a survey design in order to see how far responses are sensitive to the scope of the good being valued.

Furthermore, since heritage conservation generates values for the future, a legitimate concern in cultural heritage valuation is that of how future values might be taken into account, since one cannot survey generations yet to come. Of course, generations do overlap to some extent, and part of these future values are taken into account by the bequest motivations of current generations. But problems still arise as cultural heritage conservation sometimes involves very long-term perspectives, and future preferences with respect to art have been found to deviate from the values held by current generations (Frey 2000). It might be that, because of changing tastes, future generations will not want to conserve as much cultural heritage as does the current generation. But, in general, it is arguably more likely that that people in the future will value cultural heritage conservation more highly than the living generation. Aside from changing tastes, future generations are expected to be richer than current generations, and hence, they are likely to be willing to pay more for cultural heritage preservation. Also, it is inevitable that, over time, some cultural heritage will deteriorate or be lost: given increased scarcity, the value of the heritage will naturally increase. More research is needed on the best way to treat and account for future values. In practical terms, a sensible approach for unique and important cultural resources is to combine economic valuation with a precautionary approach, which means that any decision not to undertake preservation is afforded very careful scrutiny.

Other authors put forward more radical criticisms of cv that question the basis of economic theory, focusing on known psychological anomalies such as the disparity between the value of gains and losses (Frey 2000)—that is, when WTP questions yield different valuations than corresponding WTA questions—or suggesting that respondents may be driven by nonrational/nonmaximizing preferences, acting and behaving as citizens and not as “consumers” when facing choices concerning public goods (Blamey, Common, and Quiggin 1995; Vatn and Bromley 1995). For example, Blamey states, “Respondents often adopt a contribution model when processing scenario information, rather than the purchase model assumed by environmental economists. In contrast to the purchase model, where an individual is assumed to ask herself whether she is prepared to pay the specified amount to obtain the environmental improvement rather than do without it, the contribution model assumes that individuals treat the environmental improvement as a good cause, that warrants supporting. . . . This has the

important implication that individuals may be willing to pay more to a local environmental issue for which there are few contributors than a national issue they value more highly, but for which the costs of the intervention are to be shared by a proportionally larger number of people. . . . Price fairness is assumed to be one of a number of contingencies influencing behavioral promises in cvm studies” (Blamey 1998, 69).

While psychological anomalies do present a problem in some instances, it is meaningless for economic analysis to try to disentangle the realm of citizens’ value and that of consumers’ value: the two are intrinsically entangled when the valuation of public policy and public goods is at stake. As citizens, individuals are still influenced by their values and preferences for public goods. What is important to bear in mind is that cv values are contingent to the information provided in the valuation scenario, and preferences are sensitive to the attributes of the contingent market described. This is perfectly rational. As long as the public good and the contingent market are correctly described, credible, and incentive compatible, this should not be an issue.

Finally, in order to avoid easy misunderstanding, it is important to stress that economic valuation methods do not pretend to assess cultural values as such but to assess the economic values associated with cultural heritage—that is, the flow of benefits arising out of a physical stock. Economic values relate to the enhancement of human/individual/social well-being; they are anthropocentric and based on people’s preferences (Pearce 1993). They lend themselves to quantification and to the assessment of trade-offs between goals and resources (Robbins 1938). As discussed above, the economic value of cultural heritage is a wide-ranging, complex, and multifaceted concept, as preferences for cultural assets stem from many different motivations, ranging from self-interest to pure altruistic concerns.

Focusing on economic values, as broad and encompassing as they may be, does not mean that other values are less important. Economists do not claim that all values can be measured in money terms and be captured in actual financial flows: there will be cases where the information is inadequate, the uncertainties too great, or the consequences too profound or too complex to be reduced to a single number (Hanemann 1994). Nor do economists claim that economic values subsume all that is important in cultural heritage conservation policy. Other relevant (nonmonetary) cultural, religious, symbolic, and spiritual values also have a role to play in decision-making

processes. The point is that economics, as a social science, can and should provide complementary techniques and investigative tools to disciplines dealing with cultural issues, for a holistic assessment of cultural values.

CV has been extensively applied to the valuation of environmental goods and services (Mitchell and Carson 1989; Carson et al. 1995). However, there have been surprisingly few applications to cultural assets, in spite of the obvious links between questions of the conservation of natural and cultural goods. Cultural policy and management would benefit a great deal from a set of sound, theoretically structured, and operational evaluation tools. The next section discusses the role of economic valuation in cultural heritage and suggests a number of possible areas where these tools might be used successfully.

---

### **The Role of Economic Valuation for Cultural Policies and Institutions**

It has been argued above that cultural heritage is a mixed good, framed over a multidimensional, multivalued, and multiattribute environment, generating private and public/collective benefits for current, potential, and future users and even for nonusers. How resources are allocated and consequently how institutions and services are managed, organized, and provided affect people's well-being, attitudes, and participation toward cultural heritage. In this context, what are the cultural goals faced by policy makers and managers that economic valuation tools might help to inform? These goals, interrelated in many ways, pertain to three main areas: management, financing, and resource allocation.

#### **Cultural Destinations Management**

As far as the management of cultural destinations is concerned, economic valuation may help to inform decisions and policies of the following type:

- assessing what type of changes/attractions/exhibitions/improvements should be introduced in cultural destinations in order to maximize profits/revenues/access
  - evaluating pollution, tourism, and development damage done to cultural destinations
  - assessing what type and degree of conservation measures should be undertaken (e.g., restoration, replacement, cleaning)
  - estimating the demand for a cultural asset and predicting future demand trends

- assessing nonvisitors' potential demand and investigating the factors that might influence that demand
  - estimating price and income elasticities of demand for cultural assets
  - designing successful pricing strategies for cultural destinations: who pays what, when, and how
  - ranking cultural heritage characteristics, thus assessing priorities for new marginal improvements
  - prioritizing among competing projects at the micro/institution level
  - assessing visitor preferences both before and after the visit experience and evaluating repeated visitors' experiences
  - gathering information on how socioeconomic characteristics (age, sex, membership, income, education, attitudes) explain visitation rates and spending patterns
  - identifying groups that might be excluded from enjoying cultural heritage at certain prices and given certain management policies
  - evaluating the impacts of congestion-reduction options

#### **Financing Cultural Heritage**

As far as the financing of cultural heritage is concerned, the objectives that can be informed by economic valuation may be listed as follows:

- assessing the existence and measuring WTP for access, conservation, and improvements of cultural heritage
  - analyzing pricing policies for cultural destinations: uniform pricing, interpersonal price discrimination, voluntary prices, intertemporal price discrimination, etc.
  - investigating how the prices that people are prepared to pay vary across different socioeconomic groups (by age, sex, income, education, etc.)
  - quantifying the gap between benefits to the community provided by cultural heritage and costs incurred to provide them
  - providing information for a multisource funding strategy, based on local and national taxes, private donations, funds, entry fees, and public/private partnerships designing incentive systems to motivate and finance conservation
  - investigating whether subsidies to cultural heritage are justified and informing how much they should be

## Resource Allocation

Regarding the macro process of allocation of resources among sites and institutions, pursued by a public evaluator body, economic valuation can be used to help a number of policy decisions:

- allocating funds between cultural heritage and other areas of public spending
- gathering information of strategic policy importance about the level of public support (financial and nonfinancial) for the cultural sector or a specific cultural institution for the process of resource allocation
- allocating cultural budgets within competing institutions/ areas
- measuring people’s satisfaction for existing cultural services and then ranking institutions with respect to benchmark parameters
- appraising and ranking interventions in the cultural sector—for example, for competitive (grant) allocation
- allocating a budget within one institution/ area among competing projects
- deciding whether a given cultural asset is to be conserved and, if so, how and at what level
- assessing which sites, within a city area or a cultural district, are more worthy of investment and for which the impacts are more significant

Management, financing, and resource allocation strategies are evidently entangled, as evidenced above. Economic valuation is of use in all three spheres, for macro and micro cultural policies oriented toward access, conservation, or quality improvement goals.

Of course, economic valuation is just one among other existing economic instruments and tools that can be used in the cultural heritage context: its main aim is to demonstrate that economic values exist and to measure them. Subsequently, other economic tools can be used to “capture” those estimated values—that is, to transform them into actual cash flows. In particular, economic valuation might precede the use of instruments such as (1) local or national taxes aimed at financing culture, (2) fees aimed at regulating access and raising funds, and (3) voluntary donation mechanisms aimed at raising money without imposing a fee. The focus here is strictly on the argument that cultural economic values exist and that there are ways to measure them validly, rather than on capturing those values (see Pearce and Mourato 1998 and Bailey and Falconer 1998 for a discussion of economic capture instruments).

Despite the potential, existing cultural heritage valuation studies are scarce and limited in scope and content. The next section reviews the current body of evidence and discusses the implications of its findings.

---

## Current Evidence: Lessons and Controversies

This review focuses on the emerging literature on the valuation of cultural benefits by means of stated-preference techniques (mainly cv). As noted above, it is only in recent years that cv methods have started to be applied within the realm of cultural heritage economics, and so far, very few studies have been undertaken. A search of published and unpublished international sources uncovered just over thirty stated-preference studies of cultural goods.<sup>9</sup> Appendix I contains a summary overview of these studies. As illustrated in Figure I, the existing literature is strongly concentrated geographically, with the majority of studies coming from Europe (55 percent) and with the U.K. producing the largest share (29 percent). Some 23 percent of studies were carried out in the United States and Canada.

Early studies on cultural heritage valuation were small-scale surveys, exploratory in nature and mostly confined to finding a price for the good in question using a then-novel methodology in the sector (see, for example, Willis 1994 and Martin 1994). Since then, some progress has been achieved at various levels: sampling, study design, implementation, statistical estimation, testing the validity of the estimates produced, and exploring the nature of people’s preferences toward cultural goods. In

Figure 1 Stated-preference valuation studies of cultural heritage by country.

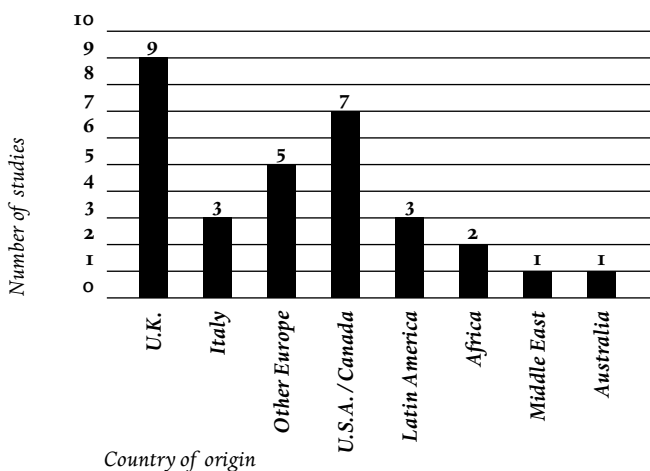



this respect, however, cultural heritage is still a long way from the level of knowledge already gathered in other areas, such as the environment or health.

Existing studies vary widely, both in terms of the type of good or activity analyzed and the type of benefit evaluated. As documented in Appendix 1, there are some instances where similar types of goods were evaluated (cathedrals, castles, archaeological sites, groups of historic buildings, recorded heritage). However, the type of benefit estimated is usually different, as is the sample frame used, making it difficult to make meaningful comparisons among studies.

While the conclusions of each study are different, some consistent findings emerge from the studies that have been conducted to date. These are discussed below.

### **The Significant Value of Heritage Conservation and Use**

Generally, the findings suggest that, on average, people attribute a significantly positive value to the conservation or restoration of cultural assets (Appendix 1). The implication is that damages to cultural goods are undesirable and that the public would be willing to pay positive amounts to avoid them or to slow the rate at which they occur. Mean values range from less than a dollar (for example, Bulgarians were found to be willing to pay about \$0.60–\$1 to preserve their famous monasteries [Mourato, Kontoleon, and Danchev 2002]) to over \$150 (for example, the conservation of an archaeological park in Italy was valued at about \$216 by local residents [Riganti and Willis 1998]), with the distribution skewed toward lower value ranges. Perhaps a more meaningful measure for comparison purposes is WTP as a proportion of per capita gross national product (GNP): typical annual household WTP amounts for cultural heritage conservation are calculated to range from 0.01 percent to 0.5 percent of per capita GNP.

The large dispersion of estimated values is due to large differences in the type and scope of the cultural change being evaluated, to taste and income variations in the sampled populations, and to disparities in value elicitation methods. Clearly, these values are only indicative and should be taken cautiously, given the small number of studies on which they are based.

### **Is It a Minority Benefit?**

Several of the studies depicted in Appendix 1 show a relatively large proportion of respondents stating a zero WTP (up to 89 percent in the case of the recreational value of

defaced aboriginal rock paintings in Canada [Boxall, Englin, and Adomowicz 1998]). Some of these responses can be considered protests against some aspect of the survey instrument (i.e., a dislike of paying taxes or a rejection of the contingent scenario) and thus are not a reflection of people's true preferences. Others, however, are "genuine" zero values arising from budget constraints, from lack of interest in cultural issues, and from the fact that cultural heritage preservation is typically ranked low among competing public issues, as is shown consistently by attitudinal questions. Hence, the welfare of a significant proportion of the population seems to be unaffected by changes in cultural goods/activities. In some instances, the positive estimated values are driven by a minority of the population—typically, the users of the cultural good and the richer and more educated segments of the population (e.g., improving the landscape of Stonehenge in the United Kingdom by tunneling a nearby road generates positive benefits to 35 percent of the U.K. population, a group that was found to be on average wealthier and more educated than the 65 percent who were not willing to pay anything for the improvement [Maddison and Mourato 2002]).

This finding has important implications for the funding of cultural heritage goods. For example, in instances where more than two-thirds of the population express a zero WTP, the imposition of a tax may be infeasible; targeted voluntary donations or entry fees may provide more appropriate means of extracting existing values (although the former invites free-riding behavior); or, if a tax mechanism is used, care must be taken to ensure that the distributional effects are taken into account with offsetting expenditures. In order to reduce distributional conflicts, education and information policies are important and should be targeted at increasing the consumption of culture by affecting tastes or by reducing the costs to disadvantaged groups of consuming culture. There is large potential for cross-fertilization between valuation of preferences for culture and the implementation of cultural educational policy.

The link among income, education, and cultural benefits found in cultural valuation studies also seems to suggest that the value of cultural heritage conservation will grow as incomes and education rise. It lends some support to the proposition that future generations might attribute a larger value to heritage conservation than do present generations, in part because of higher incomes and education levels.

## The Importance of Actual Users

Most of the studies summarized in Appendix 1 indicate that there can be significant values from recreation and educational visits to cultural destinations (e.g., foreign visitors to the Fes Medina in Morocco valued a visit at \$38–\$70 [Carson et al. 1997]). Hence, policies aimed at increasing and facilitating access to cultural sites can also be expected to enhance economic cultural values.

Nevertheless, it is misleading to assume from these results that charging users optimal entry fees will solve all the financing problems of cultural sites. First, user values alone may not be enough to deliver sustainability for the large proportion of cultural goods and services that are not unique in many respects and where substitute destinations exist, which explains the accumulated deficits and/or degradation experienced by many cultural sites. Second, it may institutionally be difficult to charge optimal prices. For example, entry fees might be regulated, or there might be a membership system in place whereby members can gain free access to certain cultural destinations in exchange for a fixed membership fee. Such a circumstance happens in the United Kingdom with the National Trust, a charity founded in 1895 to preserve places of historic interest or natural beauty permanently, for the benefit of the nation. The National Trust is the largest conservation charity in Europe, with 251 properties opened to the public and 2.5 million members in 1997. Members account for a large proportion of all visits to the Trust's properties, but, as they are entitled to free access via their membership fee, they would therefore not be affected by increases in entry fees.

A number of related issues should also be taken into account when user pricing mechanisms are designed: on the one hand, the effect of higher prices on visitation rates should be carefully considered and addressed, given the current focus on making heritage available to the general public; on the other hand, the possible trade-off between access and conservation (i.e., too many visitors might cause deterioration of a site by overuse) should be analyzed explicitly, and future studies should attempt to measure tourist carrying capacity of a site, as well as calculate any possible congestion costs.

## What about Nonusers?

Studies dealing with nonuse values of cultural heritage sites show that these can be important (Appendix 1). In cases where the relevant population benefiting from improvement or maintenance of the cultural good is thought to be sizable, possibly crossing national borders, the total aggregated benefit can be very large: even when individual WTP is very small, when multiplied by a vast number of people, a large value will be obtained. This is the case when unique and charismatic cultural heritage goods are at stake. For example, the estimated value of improving the landscape of Stonehenge for the U.K. population was found to be mainly driven by nonuse values (mainly a desire to protect the site for future generations), with 53 percent of the population never actually having visited the stone circle (Maddison and Mourato 2002).

However, as noted above, there is a trade-off, as the available evidence also suggests that the proportion of those stating zero WTP is largest among nonusers. Drawing from the environmental valuation literature, nonuse values are also thought to decline with the availability of substitute sites and with households' distance from the site ("distance decay"). Future research should pay close attention to the geographical limits of WTP.

## The Issue of Embedding

It was already mentioned how the issue of embedding or insensitivity to the scope of the change being valued might affect cultural values. Indeed, in an early cultural valuation study, Navrud, Pedersen, and Strand found that respondents were insensitive to the scope of the air pollution damages to the Nidaros Cathedral in Norway (Navrud, Pedersen, and Strand 1992). This potential problem has been insufficiently addressed by the existing literature.

Evidently, embedding will be less of a problem for flagship cultural goods with no substitutes (e.g., the Pyramids in Egypt). But it may distort results significantly when cultural goods perceived as being nonunique are evaluated (e.g., historical buildings, castles, churches, and cathedrals): for example, the estimated values for a particular cultural good may reflect a desire to preserve all similar goods and thus overstate the value of the good. And, as Navrud, Pedersen, and Strand discussed, this type of bias may also affect the evaluation of the scope and duration of conservation policies for a single site (Navrud, Pedersen, and Strand 1992). More research is needed in this important area.

## **“Quick and Dirty” Valuation Studies**

The lack of financial resources and/or the lack of knowledge about valuation methods has led to several poor valuation studies, in terms of consistency with economic theory, survey design, statistical performance, and sample significance. This is as true for cultural heritage valuation as it is for valuation studies in other areas. In some cases, the lack of sound preliminary investigation—by means of pilot studies, focus groups, and interviews—has led to “quick,” and consequently faulty, studies, confirming the golden rule of empirical analysis: the result one gets is dependent on the quality of the data one inputs. Moreover, a good valuation study requires adequate financial and human resources, as it is a time-consuming and complex activity; but, more often than not, sponsoring bodies are unwilling to allocate enough time and resources for practitioners to produce a good study. The recent emphasis on producing best-practice guidelines developed by field practitioners is an attempt to ameliorate this situation (Arrow et al. 1993; Bateman et al. 2002).

Whatever the budget available, good knowledge of the theoretical underpinnings of valuation, of the lessons yielded by previous studies, and of survey implementation guidelines helps in achieving efficiency (measured in quality of output divided by costs). Interdisciplinary teams of economists, other social scientists, cultural managers, and marketing researchers may set up valuable and reliable cost-effective studies, exploiting economies of scale in (1) preparing more than one valuation study/experiment at the same time, and (2) integrating the valuation experiment with broader socioeconomic or marketing investigations.

### **Should Decisions about Cultural Heritage Conservation Be Left to Experts?**

A common criticism of survey-based economic valuation approaches is that decisions about cultural assets should not be left in the hands of the public, thought to be too ignorant about cultural goods to possibly be able to make sensible judgments about them. Is expert judgment an alternative to survey-based (stated- and revealed-) preference analysis? Cultural experts clearly play a leading role in determining the value of cultural heritage. Nonetheless, relying only on experts' judgment may be dangerous, leading to improper allocation of resources, arbitrariness, lobbying pressures for funding, and paternalism.

In fact, cultural valuation studies that have canvassed opinions from both experts and the general public have found consensual views in many areas (Mourato et al. 2001). Moreover, as has been pointed out, most valuation studies have uncovered significant cultural values even for small changes, overcoming the fear that the public does not know enough about the cultural sector to be able to hold sensible values on it.

Top-down experts' perceptions and bottom-up public demands should be brought together and should balance each other within the realm of cultural policy, since cultural heritage is a complex economic good requiring a comprehensive and participatory approach to management that includes all stakeholders. In the context of valuation studies, while expert knowledge should be sought at various stages of the research process, it is probably most useful at the designing stages of the valuation survey, to inform the context and framing of the valuation scenario, enhancing its credibility and the usefulness of the results for formulating policy.

It has been discussed already how demand-led approaches are fundamental to justifying the spending of limited public money on cultural heritage, how resource allocation within the sector is increasingly based on generated “consumer benefits,” and how cultural destinations are becoming more consumer oriented—investigating and reaching new markets, encouraging repeat visits by change and renewal, providing integrated experiences, and striving to surpass expectations. The emerging valuation literature supports this modern view: valuation studies have invariably uncovered large average values among the lay public for cultural assets. Cultural heritage seems to be an important part of people's lives, and accordingly, they are willing to trade off some of their limited income to access it and to protect it. Many more good-quality studies are needed to confirm these early findings and to address the several gaps in knowledge identified above.

---

### **A New Framework for the Valuation of Cultural Heritage**

In this section, two avenues are proposed for improving the assessment of cultural values in a more integrated and holistic environment. One constitutes an improvement over current economic valuation techniques that comes from within economics; another complements and expands standard economic valuation practices by making use of complementary lines of inquiry from other social disciplines.

## New Economic Tools: Choice Modeling Approaches

Partly as a response to the problems experienced by researchers in CV studies, valuation practitioners are increasingly developing an interest in alternative stated-preference formats such as choice modeling (CM).<sup>10</sup> CM is a family of survey-based methodologies for measuring preferences for nonmarket goods, where goods are described in terms of their attributes and of the levels that these take. Respondents are presented with various alternative descriptions of the good, differentiated by their attributes and levels, and are asked to do one of the following:

- (1) rank the various alternatives in order of preference,
- (2) rate each alternative according to a preference scale, or
- (3) choose their most preferred alternative out of the set.

By including price or cost as one of the attributes of the good, WTP can be indirectly recovered from people's ranks, ratings, or choices. As CV, CM can also measure all forms of value, including nonuse values.

CM has one main advantage over standard CV formats: its capability to deal with multidimensional changes. By describing a good or policy in terms of its component attributes, values can be obtained not only for the good/policy as a whole but also for each of its attributes. Furthermore, the method avoids an explicit elicitation of WTP by relying instead on expressed choices or rankings among alternative scenarios from which WTP can be indirectly inferred: this might reduce the incidence of people protesting or refusing to answer the valuation question.

The conceptual microeconomic framework for CM lies in Lancaster's characteristics theory of value,

which assumes that the utility that consumers get from a good can be broken down into the utilities of the composing characteristics/attributes of the good (Lancaster 1991). Empirically, variants of CM have been widely used in the market research and transport literatures (e.g., Hensher 1994; Green and Srinivasan 1978; Hensher and Johnson 1974), but the method has only relatively recently been applied to other areas, such as the environment or culture. Louviere, Hensher, and Swait (2000), Bennett and Blamey (2001), and Hanley, Mourato, and Wright (2001) provide recent and extensive overviews of CM techniques and their application to the environmental field.<sup>11</sup>

A typical CM exercise is characterized by a number of key stages. These are described in Table 3.

As an example, consider an area abundant in properties of historic interest, and suppose that the local cultural authorities want to find out which attributes of the properties attract the most visitors and which are valued the most. Table 4 exemplifies a CM exercise that could be used to estimate tourist demand for various historic property attributes. Respondents are presented with two imaginary (but realistic) property descriptions (there could be more than two) and then asked to choose which property they would prefer to visit (they are also given the option of not visiting any of the properties described). Each property is defined in terms of five attributes: existence of a garden; architectural style of the house; quality of collections (furniture, porcelain, glass, tapestries, or paintings); visitor facilities (cafeteria/restaurant, shops), and entry fee. Each attribute can take various levels. For example, the garden attribute might have only two levels ("has a garden" or "no garden"), while the entry fee attribute might have four levels (\$1, \$5, \$20, \$30). Typically, each

Table 3 Stages of a CM exercise.

Stage	Description
Selection of attributes	Literature reviews and focus groups are used to select the attributes of the good to be valued that are relevant to people, while expert consultations help to identify the attributes that will be impacted by the policy. A monetary cost is typically one of the attributes to allow the estimation of WTP.
Assignment of levels	The attribute levels should be feasible, be realistic, and span the range of respondents' WTP values. A baseline, status quo level is usually included (e.g., a no-payment level in the case of WTP).
Choice of experimental design	Statistical design theory is used to combine the levels of the attributes into a number of alternative scenario descriptions.
Construction of choice sets	The scenarios identified by the experimental design are then grouped into choice sets to be presented to respondents. Choice sets can have two or more alternative scenarios.
Measurement of preferences	Respondents are typically asked to choose their most-preferred alternative out of each choice set, or to rank the alternatives in order of preference.

respondent would be given a number of these choice sets to answer, each with different property descriptions.

If the 1990s have witnessed the emergence of the cv method within the realm of cultural economics, the first decade of the new century may see the development of cm applications to the cultural heritage valuation arena. This is because the many dimensions, attributes, and values characterizing the supply and demand of cultural goods and services lend themselves to analysis by mechanisms that have the capability of dealing with situations where changes are multidimensional, of analyzing trade-offs among them, and of eliciting separate values for the various functions of interest. In particular, pursuing an attribute-based valuation—by breaking down cultural institutions and policies into a set of functions and services—might serve a number of objectives relevant to cultural policy:

- to measure the total value associated with different cultural property or policy descriptions (i.e., properties/policies described by different attribute levels)
- to measure the contribution to the total value of a cultural site of single attributes, services, or functions (of a public or private nature)
- to determine possible trade-offs among attributes (e.g., such as the intrinsic trade-off between access and conservation)
- to derive an implicit ranking of attributes according to user preferences<sup>12</sup>
- to determine public support of specific cultural property or policy scenarios
- to estimate the market share of a particular site
- to avoid some of the protests arising from direct elicitation of WTP for cultural goods

*Table 4 Example of a choice set from a CM exercise.*

Features	Property A	Property B
Garden	Has a garden	No garden
Architectural style	Remarkable	Unremarkable
Collections	Exceptional	Exceptional
Facilities	Large restaurant/shop	Basic cafeteria/shop
Entry fee	\$20	\$5

- I would prefer to visit property A
- I would prefer to visit property B
- I would not visit any of the properties

Being survey based, cm approaches also suffer from the problems associated with survey techniques previously discussed. A further limitation of this approach lies in the cognitive difficulty to respondents associated with complex choices between bundles with many attributes and levels. Previous research in the marketing and environmental literatures by Ben-Akiva, Morikawa, and Shiroishi (1991), Chapman and Staelin (1982), Hausman and Ruud (1987), and Foster and Mourato (2002) found evidence of unreliable and inconsistent choices/ranks. In particular, respondents were found to (1) choose options that are worse than others in all respects (dominated options), (2) make choices that are intransitive (i.e., choose A over B, B over C, and then C over A), and (3) make inconsistent choices across choice sets (i.e., choose A over B in one choice set and B over A in another). The number of illogical choices seems to increase with the complexity of the choice/ranking task (i.e., with the number of attributes, levels, choice sets, and scenarios in each task and when choices are made between alternatives that respondents dislike). Possible explanations for the occurrence of these problems include respondent fatigue, learning effects, and the adoption of rules of thumb to facilitate the choice task (like choosing options with reference to one attribute only, ignoring all the others). For these reasons, cm exercises should be as simple as possible, using a limited number of attributes, levels, and choice sets, so as to avoid overburdening respondents with information.

To summarize, cm has explicit advantages over the cv method in the analysis of goods of a multidimensional nature. As far as cultural heritage is concerned, cm brings together a structured economic theoretical framework, a powerful and detailed capacity of evaluation, and a great variety of application possibilities. It is suggested here to add this comprehensive valuation technique to the available box of cultural economic tools to be drawn upon by cultural policy makers and cultural managers as needed. Further research and applications to cultural policy are therefore strongly encouraged.

### **Integrating Instruments for Socioeconomic Evaluation of Cultural Heritage**

Stated-preference techniques were argued above to be capable of producing valid and reliable monetary measures of the benefits associated with cultural heritage access, conservation, and improvements. But the suggestion that these methods produce “theoretically correct” measures of value should not be taken as an argument for

their superiority over other evaluation tools. It is one thing to acknowledge that WTP has its theoretical basis in welfare economics (and in that sense is “theoretically correct”), but it is another thing to use that as an argument *per se* for applying it to cultural values. The rightness of an evaluation approach is to be judged neither from its disciplinary basis (economics) nor from its theoretical foundation (neoclassical welfare economics). Rather, it is to be judged on the basis that its value judgments are compatible to those society holds for cultural values, for which economic valuation is being undertaken.

Furthermore, nonmarket valuation remains controversial. As was discussed above, the techniques are subject to a number of potential flaws—on theoretical, methodological, and empirical grounds—that are all the more serious when studies are conducted without reference to accepted best-practice guidelines (Bateman et al. 2002; Arrow et al. 1993; Mitchell and Carson 1989). Of course, this in itself is hardly surprising, as no method is without problems; but failure to address and resolve these limitations may result in considerable misrepresentation of the impacts of important policies, projects, and regulations, as nonmarket valuation approaches are increasingly used by governments, international organizations, and other public and private bodies.<sup>13</sup>

Hence, as appealing as they may seem to economists, consumer sovereignty and economic valuation should not be the only driving engines as far as cultural policy-making assessment is concerned, and their relative validity should be assessed by comparison with the performance of competing instruments. And herein lies the main problem faced by decision makers and cultural managers interested in applying a scientific approach to assess the value of their policies: while economic valuation critics have been quick to find fault with the technique, they have been very slow to present better and viable alternatives to economic evaluation. Alternative noneconomic approaches at the moment are either incipient or nonexistent. Even if these alternative tools were readily identifiable, the question would still remain of how to integrate them in a logical, credible, and workable way.

Despite the apparent lack of competing, analytically sound, noneconomic evaluation techniques, it is still worthwhile to try to outline the possible structure of an integrated approach to cultural valuation. Rather than a radical departure from current practice, a possibility is to use existing lines of inquiry from market research, psychology, and other social sciences within an economic valuation study, to complement and enhance its capabilities,

using qualitative information to further our understanding of economic values in the context of cultural policy.

The following social science tools might play a useful role in complementing economic techniques in a new integrated approach to assess cultural values.

#### EXPERT JUDGMENT

With careful integration, expert judgments and public valuation may play useful complementary roles toward the assessment of cultural values. As noted previously, valuation practitioners know that the preparation of a well-structured survey needs to receive information from many sources (i.e., experts, people working at cultural institutions, museum managers, users, and nonusers) in order to take into account comprehensively all the relevant aspects of the problem at stake. Integrating expert views in preliminary phases is advisable in this context (see Mourato et al. 2001 for an example).

Taking this practice a step further, alternative approaches to nonmarket valuation, where elicitation of contingent values actually derives from small focus groups of stakeholders (rather than from the general public), have been proposed (Cookson 1998). Although the goal of eliciting people’s WTP from well-informed and interested agents is acceptable and useful, to use this technique as the sole method to elicit values seems to be unrealistic and to suffer from many theoretical, statistical, and procedural distortions—namely, departing from a demand-led assessment. Valuation studies should not be influenced by experts’ perspective only, which is to be considered among other important views. Hence, in our opinion, the use of experts and other key stakeholders has an important role to play, mostly in the design stages of the economic survey instrument and in the *ex-post* evaluation of results.

#### SOCIAL ASSESSMENT

Social assessment methods were developed by the World Bank in order to provide an integrated framework for incorporating participation and social analysis into development projects (World Bank 1994). They involve consultations with stakeholders and directly and indirectly affected groups. These methods offer great potential to complement an economic assessment of cultural policies, as issues such as gender, ethnicity, social impacts, and institutional capacity also need to be taken into account in cultural policy evaluation.

The complementary use of social assessment tools in parallel with an economic valuation methodology will help ensure that the change in the cultural good

(e.g., a management change aimed at increasing access) is acceptable to the range of people intended to benefit from it, and that gender and other social differences are reflected in the policy evaluation. It is also essential to identify adverse social impacts of cultural projects and to determine how they can be mitigated (e.g., the local social impacts of increases in entry fees to cultural destinations). Impacts in disadvantaged groups (e.g., the poor, less educated groups, minority groups, and indigenous people) are particularly important to assess and overcome.

#### EXPERIMENTAL PSYCHOLOGY TOOLS

Stated-preference methods are designed to uncover values rather than motivations. Thus, experimental psychologists have argued that there is a need to go deeper into understanding individual motivations for WTP than is common practice among valuation practitioners (Kahneman, Ritov, and Schkade 1999; Tversky and Kahneman 1982; Green and Tunstall 1999; Kahneman and Thaler 1991). In brief, the psychological approach claims that the set of assumptions defining the microeconomic neoclassical environment is too restrictive, too static, and not sufficiently focused on the process of preference formation and on underlying motivations. Several contributions have emerged from this line of psychological/economic research, with some interesting, although generally ambiguous, results. The abstract idea of *homo economicus* certainly appears in need of being extended and developed, but it does not arise as flawed in its foundations.<sup>14</sup>

It seems that the entangled and complementary realms of individual motivations and economic values should be the joint targets of socioeconomic investigation. In other words, the joint use of economic and behavioral psychology tools is both needed and encouraged. For example, the model developed by Fishbein and Ajzen offers a way to infer behavior by a chain of connections, starting from beliefs and then going to attitudes and intentions and finally to behavior (Fishbein and Ajzen 1975). Along the chain, each step is determinant and explanatory for the following one. Stated-preference methods elicit WTP measures that are “intentions of behavior.” Therefore, an interesting way of testing the validity of stated values is to examine closely the relationship between them and the beliefs and attitudes held by respondents toward the cultural good of interest and toward culture in general, via the inclusion of adequate measurement scales in the survey instrument. Since stated-preference studies typically elicit varying amounts of qualitative and non-monetary information as well as monetary values (both in

the focus group stages and in the final questionnaires), it would not be infeasible to expand the qualitative component of these surveys. Another avenue already pursued by some authors is to check whether intended behavior, as expressed by WTP, is a satisfactory indicator of real behavior; this checking can be done in a laboratory setting (see Foster, Bateman, and Harley 1997 for a review).

#### PARTICIPATORY RURAL APPRAISAL

Participatory rural appraisal (PRA) is an approach for shared learning between local people and outsiders (Chambers 1992). The term is somewhat misleading, as PRA techniques are applicable in urban settings and can be employed to complement economic assessments. In the context of cultural heritage evaluation, these techniques can enable researchers and local people to work together in identifying, planning, and designing the best cultural policy package. There is a wide range of participatory data collection methods that can be used; these include semistructured interviews, focus groups, non-monetary preference ranking exercises, participant observation, transect walks, mapping exercises, and other visual illustrations.

PRA techniques might constitute a valuable aid in furthering our understanding of people’s motivations for cultural use and conservation and in providing insights into their behavior, particularly in what relates to uses of cultural heritage in developing contexts. For example, there may be values that a structured survey will not be able to uncover properly and that only careful observation and group exercises might identify. This might be the case in assessing values that local communities in developing countries hold toward their cultural heritage.

#### MARKETING RESEARCH

Marketing studies are highly complementary to economic inquiries. Marketing practitioners have decades of experience in designing surveys, in administration, and in analysis, and these professionals are constantly developing new methodological variants and survey interfaces (Malhotra 1999); economic valuation research could advance more rapidly by learning from this related discipline. For example, focus groups are still not used in many CV surveys’ developmental stages, although they are standard practice in marketing research. Moreover, the CM framework described above derives from the marketing literature, which was subsequently extended to the economics realm. Marketing investigation and economic studies, although aimed at different goals, share many common objectives within a demand-led approach, and economics

of scale can easily be exploited by joint research.

As we can see from the above discussion, there is a great potential for cultural experts (anthropologists, architects, art critics, etc.), psychologists, marketing researchers, and other social scientists to play an important role in the process of economic evaluation of cultural assets. Conversely, the analytic rigor and quantitative precision favored by economic valuation tools can be usefully borrowed by other disciplines.

For this potential to become a reality, economic valuation instruments must break with some misconceptions and be made available for routine use in the cultural field, for the different purposes envisaged in this paper. As Nuti observes, "The real test will come when and if *CV* will be introduced as a routine method of evaluation in public decisions. . . . The introduction of criteria and methods as a routine in the control of public expenditure [in Italy] will surely prove to be a lengthy and very frustrating accomplishment—this is not to say that it is not worth pursuing" (Nuti 1998, 96). It will also be necessary for other social scientists to be willing to collaborate with economists in joint research efforts to assess cultural values, and to bring with them to the research forum complementary social research tools as suggested above, both quantitative and qualitative in nature, where cross-fertilization with economics might be feasible and desirable. It would be important, for this aim, to develop investigation and policy using a framework of "tools and targets." After a clear definition of the set of economic and of noneconomic tools and of economic and noneconomic targets, it would be easier and more effective to implement sound strategies and sound multidisciplinary research on cultural issues.

Integrated approaches are what cultural policy needs. Although the development of such approaches has proved to be highly difficult in the past, the authors hope that this paper will contribute to the clarification of misconceptions, to the achievement of reconciliation, and to the mitigation of resistances to the use of economic tools.

---

## Conclusions

This paper has attempted to highlight what the role of microeconomic evaluation techniques in the cultural sector might be. Despite criticism, economic valuation methods remain among the few analytical instruments capable of producing valid and reliable empirical measures of the benefits of cultural heritage conservation. They are there-

fore an important tool for ascertaining efficient outcomes of allocating the limited resources available for cultural heritage. While economic valuation does not deny other value dimensions, it does have a specific and special role to play in cultural policy toward heritage conservation and development.

More generally, people's preferences should inform and influence the ranking of public priorities, and they should affect the direction of change in policy making in the cultural sector. If individuals would like the government to support the existence and conservation of cultural heritage, consumer sovereignty would be violated if the public authority did not pursue this aim. If people express a positive economic value for future generations, it would be odd if the government and cultural institutions neglected these, however elusive, nonuse values. Similarly, national and local governments should be cautious to invest in cultural infrastructures without having a clear indication of people's preferences on public priorities and, specifically, on cultural priorities. In most cases, culture does not rank high in public priorities. Thus, a careful assessment of preferences is a worthwhile exercise for knowing where, at the margin, economic value is highest, across sectors and within the cultural sector. To deny these considerations to be a part of decision making would be to deny the fact that individuals hold strong opinions and values about cultural policy, mankind heritage, and future generations.

As with environmental resources, if the alternative to economic valuation is to put cultural heritage value equal or close to zero, the cultural sector would, as a result, be severely damaged. Ignoring economic preferences can lead to undervaluing and underpricing of cultural assets. This, directly and indirectly, reduces the amount of financial resources available to cultural institutions relative to other public priorities. It also gives an incentive for people to perceive cultural heritage assets as open-access resources without enforced property rights, and not as mixed-collective goods with an attached set of clearly defined values and stakeholders. Open access, if it emerges and affirms itself as the social norm, is disruptive for nonmarket assets.

The aim of the stated preference valuation methods discussed in the paper is not only to justify and influence decisions but also to provide information, as food for decision making in the cultural sector. Three levels of relevancy and use for estimates of economic values were seen to arise in the sector. The first level is concerned with economic-management issues at the level of cultural insti-



tutions, and the target is estimating demand schedules, pricing schedules, and price elasticities; prioritizing among projects; ranking potential investments; and evaluating impacts of pollution, tourism, development, and so on. The second level is related to financial aspects and involves analyzing pricing policies, designing incentive systems to encourage conservation, and justifying subsidies. The third level is more politically oriented, and the target is to estimate values for gathering information of strategic policy importance—i.e., allocation of budget to the cultural sector and cultural institutions, reflecting their relative value, and allocation of resources within the sector where the economic value is higher.

For the future, the task is to develop and establish a comprehensive multitool and multidisciplinary framework for the measurement of cultural values, as a response to the complex, multifaceted, and multivalue nature of cultural heritage. The authors have argued that economic instruments should be used as complementary means for socioeconomic analysis, together with a range of other tools from other disciplines. Measuring cultural benefits/values in this context should therefore be the output of a multidisciplinary teamwork that includes not only economists and conservation specialists but also other social scientists.

In what concerns the microeconomic realm, such a framework can be built on a set of economic tools that include revealed- and stated-preference techniques—in particular, CV and CM, which consistently rely on economic theory for estimating economic preferences. In what concerns other disciplines, it was suggested that some existing social research tools could be integrated and used in conjunction with economic valuation methods to provide a fuller assessment of complex cultural values that cannot be fully described and measured by any one discipline or method. This paper identified a few, by no means exhaustive, complementary lines of inquiry, such as expert judgments, social assessments, psychological measures of attitudes and beliefs, laboratory experiments, participatory appraisal techniques, and marketing research methods. It is likely that many other relevant measurement approaches exist in other disciplines that could be adapted for the purposes of assessing cultural values, within the proposed multidisciplinary framework.

Hence, by using the largest possible set of theoretically consistent and operational tools, cultural targets will be achieved in a more effective and efficient manner. To make this framework operational, the use and widespread understanding of evaluation technique targets is

necessary to close gaps between economics and other social cultural disciplines. A definition in terms of tools and targets is helpful insofar as it delimits the application environment of each discipline. Building on both economic instruments and other tools developed by social sciences dealing with culture, researches can establish a comprehensive framework of microlevel valuation.

It is hoped that an interdisciplinary discussion might advance and receive stimulus as a result of the ideas developed here.

---

## Notes

1. See, for example, Kenkel, Fabian, and Tolley (1994) for health research examples, Maddison et al. (1996) for transport references, and Cook and Ludwig (2000) for an example of an application to crime reduction.
2. It is also important to note that the concepts of economic value and financial value are distinct, although there are linkages between the two. Financial value, such as the price of an antique manuscript sold in an auction, is part of economic value but does not exhaust it. In many cases, the financial value is not even the most important part of the total economic value of the cultural asset. As mentioned above, economic values embrace also the broader social value of an asset, including option values and a range of nonuse values.
3. Note that the concept of economic value is a reflection of people's preferences and therefore explicitly anthropocentric. An analysis of other types of values is beyond the scope of this paper.
4. In cases where a building or structure has no special cultural significance, the maintenance cost approach may be considered satisfactory, given the cost of conducting original valuation studies and the absence of any significant nonuse values.
5. Other methods used for measuring cultural values include the economic-impact-analysis literature. This analysis is limited to observable effects on indicators such as consumption, employment, income, and public revenue (Vaughan 1984; Greffe 1990; Martin 1994). Economic dimensions such as employment are clearly important; yet, by neglecting non-market benefits, potentially powerful additional arguments in favor of cultural heritage conservation are being ignored. Moreover, employment is not a primary goal of cultural policies. There are also some references to the use of multicriteria analysis in the context of cultural goods, but there are no insights as how actually to estimate nonuse values (Fusco Girard 1990).
6. Detailed reviews of the various techniques can be found in Mitchell and Carson (1989); Freeman (1994); Pearce, Whittington, and Georgiou (1994); Bateman et al. (2002); Garrod

and Willis (1999); Bateman and Willis (1999); Hanley, Mourato, and Wright (2001); Louviere, Hensher, and Swait (2000); and Bennett and Blamey (2001).

7. Other stated-preference methods, not addressed here, are political markets (referendum) and the use of laboratory experiments (in place of surveys).
8. Of related interest, Foster et al. (2001) provide a detailed analysis of the extent of free riding in charitable giving in the U.K. and of possible incentives to reduce this behavior.
9. As a comparison, Carson et al. (1995) produced a bibliography of published and unpublished environmental cv studies: even as early as 1995, their list had over two thousand entries from more than forty countries.
10. A variant of this approach is sometimes known, within the marketing field, as conjoint analysis.
11. In order to reduce the cognitive burden to respondents and to provide more information on specific details of the valuation, some authors have proposed to integrate wtp elicitation within a multiattribute environment structured on a so-called multiattribute analysis (Satterfield, Slovic, and Gregory 2000; Gregory, Lichtenstein, and Slovic 1993). While the valuation tool proposed in this paper is different, it is also framed over a multiattribute environment.
12. The possibility of deriving an implicit ranking of attributes (Hanley, Wright, and Adamowicz 1998) is relevant, as it allows considerations on both monetary and nonmonetary measures of value. Economic appraisal can address choices where all of the costs and benefits can be measured in money terms, but it can also be used as a basis for making decisions and providing information support where elements of costs and benefits cannot be given money values (Creigh-Tytle, Dawe, and Stock 2000). CM is compatible with a broader range of appraisal techniques in which monetary assessments might be complemented by weighting and scoring analysis (multiattribute utility) to assess the importance of benefits that are not measured in monetary terms but that may be quantified. Weighting and scoring allow the construction, for each option, of an index of "suitability," which synthesizes the ratio of quantified benefits and costs. Using the implicit survey rankings as scores/weights reduces the subjectivity of these analyses.
13. Examples of official use of nonmarket valuation techniques in the U.K. government are increasingly frequent: the figures used to estimate the costs of morbidity in the context of transport accidents, air pollution, and violent crime are partly based on cv studies (e.g., Brand and Price 2000); a large-scale cv study was commissioned to assess the external damages caused by quarry activities, in order to inform the level of an aggregates tax (London Economics 1999); and a cv study of the heritage benefits associated with constructing an expensive tunnel for a road near Stonehenge was used as supporting evidence for the social and economic desirability of the project (Maddison and Mourato 2002).
14. See also McFadden (1999) on this core point.

## References

- Arrow, K., et al. 1993. Report of the NOAA Panel on Contingent Valuation. *Federal Register* 58(10):4,602-14.
- Bailey, S. J., and P. Falconer. 1998. Charging for admissions to museums and galleries: A framework for analysing the impact on access. *Journal of Cultural Economics* 22(2-3):167-77.
- Bateman, I., et al. 2002. *Economic Valuation with Stated Preference Techniques: A Manual*. Cheltenham, U.K.: Edward Elgar.
- Bateman, I., and K. Willis. 1999. *Valuing Environmental Preferences: Theory and Practice of the Contingent Valuation Method in the US, EU, and Developing Countries*. Oxford: Oxford University Press.
- Beltran, E., and M. Rojas. 1996. Diversified funding methods in Mexican archaeology. *Annals of Tourism Research* 23(2):463-78.
- Ben-Akiva, M., T. Morikawa, and F. Shiroishi. 1991. Analysis of the reliability of preference ranking data. *Journal of Business Research* 23:253-68.
- Bennett, J., and R. Blamey, eds. 2001. *The Choice Modelling Approach to Environmental Valuation*. Cheltenham, U.K.: Edward Elgar.
- Blamey, R. 1998. Contingent valuation and the activation of environmental norms. *Ecological Economics* 24(1):47-72.
- Blamey, R., M. Common, and J. Quiggin. 1995. Respondents to contingent valuation: Consumers or citizens? *Australian Journal of Agricultural Economics* 40(2):263-88.
- Bolling, J., and V. Iversen. 1999. Tourists' willingness to pay for restoration of stone town to its original state and stopping habitat destruction in Jozani Forest Reserve, Zanzibar. M.Sc. thesis, Agricultural University of Norway.
- Boulier, B. L., and R. S. Goldfarb. 1998. On the use and non-use of surveys in economics. *Journal of Economic Methodology* 5(2):1-21.
- Boxall, P. C., J. Englin, and W. Adamowicz. 1998. Valuing undiscovered attributes: A combined revealed-stated preference analysis of North American Aboriginal artifacts. Paper presented at the World Congress of Environmental and Resource Economics, Venice, June.
- Brand, S., and R. Price. 2000. *The Economic and Social Costs of Crime*. Home Office Research Study 217. London: Home Office.
- Carson, R. T., et al. 1995. *A Bibliography of Contingent Valuation Studies and Papers*. La Jolla, Calif.: Natural Resource Damage Assessment, Inc.
- Carson, R., et al. 1997. Non-Moroccan Values for Rehabilitating the Fes Medina. Report to the World Bank on the Fes Cultural Heritage Rehabilitation Project.
- Carson, R. T., T. Groves, and M. J. Machina. 1999. Incentive and informational properties of preference questions. Plenary address, Ninth Annual Conference of the European Association of Environmental and Resource Economists, Oslo, Norway, June.
- Chambers, R. 1992. *Rural Appraisal: Rapid, Relaxed, and Participatory*. Institute of Development Studies Discussion Paper 311. Sussex, U.K.: Institute of Development Studies.
- Chapman, R. G., and R. Staelin. 1982. Exploiting rank ordered choice set data within the stochastic utility model. *Journal of Marketing Research* 19:288-301.

- Clawson, M., and J. Knetsch. 1966. *The Economics of Outdoor Recreation*. Baltimore: Johns Hopkins University Press.
- Cook, P. J., and J. Ludwig. 2000. *Gun Violence: The Real Costs*. New York: Oxford University Press.
- Cookson, R. 1998. An alternative approach to valuing non-market goods. In *Environmental Valuation, Economic Policy, and Sustainability*, ed. P. Mason and M. Acutt. Cheltenham, U.K.: Edward Elgar.
- Coulton, J. C. 1999. Optimal cultural heritage allocation: A model and contingent valuation study. M.Sc. thesis, University College London.
- Couper, A. 1996. The principal issues in underwater cultural heritage. *Marine Policy* 20(4):283–85.
- Creigh-Tyte, S., G. Dawe, and T. Stock. 2000. *The White Book. Option Appraisal for Expenditure Decisions*. Technical Paper No. 2. London: Finance Division, Department for Culture, Media, and Sport.
- Darnell, A. 1998. Some simple analytics of access and revenue targets. *Journal of Cultural Economics* 22(2–3):189–96.
- Davies, S. 1994. *By Popular Demand*. London: Museums and Galleries Commission.
- Dixon, J. 2000. Estimating economic rents from tourism in Jordan. World Bank Web page, [www.esd-worldbank.org](http://www.esd-worldbank.org).
- Feldstein, M., ed. 1991. *The Economics of Art Museums*. Chicago: University of Chicago Press.
- Fishbein, M., and I. Ajzen. 1975. *Belief, Attitude, Intention, and Behavior: An Introduction to Theory and Research*. Boston: Addison-Wesley Longman.
- Fisher, A. C. 1996. The conceptual underpinnings of the contingent valuation method. In *The Contingent Valuation of Environmental Resources: Methodological Issues and Research Needs*, ed. D. J. Bjornstad and J. R. Kahn. Cheltenham, U.K.: Edward Elgar.
- Foster, V., et al. 2001. *The Price of Virtue: The Economic Value of the Charitable Sector*. Cheltenham, U.K.: Edward Elgar.
- Foster, V., I. Bateman, and D. Harley. 1997. A non experimental comparison of real and hypothetical willingness to pay. *Journal of Agriculture Economics* 48(2):123–38.
- Foster, V., and S. Mourato. 2002. Testing for consistency in contingent ranking experiments. *Journal of Environmental Economics and Management* (in press).
- Freeman, A., III. 1994. *The Measurement of Environmental and Resource Values: Theory and Methods*. Washington, D.C.: Resources for the Future.
- Frey, B. 2000. Evaluating cultural property: The economic approach. *Journal of Cultural Property* 6:231–46.
- Fusco Girard, L. 1990. *Risorse architettoniche e culturali: Valutazioni e strategie di conservazione*. Milan: Franco Angeli.
- Garrod, G. D., et al. 1996. The nonpriced benefits of renovating historic buildings: A case study of Newcastle Grainger Town. *Cities* 13(6):423–30.
- Garrod, G. D., and K. Willis. 1999. *Economic Valuation of the Environment*. Cheltenham, U.K.: Edward Elgar.
- Green, C., and S. Tunstall. 1999. A psychological perspective. In *Valuing Environmental Preferences*, ed. I. Bateman and K. Willis. Oxford: Oxford University Press.
- Green, P., and V. Srinivasan. 1978. Conjoint analysis in consumer research: Issues and outlook. *Journal of Consumer Research* 5:103–123.
- Greffe, X. 1990. *La valeur économique du patrimoine*. Paris: Anthropos.
- . 1999. *La gestion du patrimoine*. Paris: Anthropos.
- Gregory, R., S. Lichtenstein, and P. Slovic. 1993. Valuing environmental resources: A constructive approach. *Journal of Risk and Uncertainty* 7(2):177–97.
- Grosclaude, P., and N. C. Soguel. 1994. Valuing damage to historic buildings using a contingent market: A case study of road traffic externalities. *Journal of Environmental Planning and Management* 37(3):279–87.
- Hanemann, M. 1994. Valuing the environment through contingent valuation. *Journal of Economic Perspectives* 8(4):19–43.
- Hanley, N., S. Mourato, and R. Wright. 2001. Choice modelling approaches: A superior alternative for environmental valuation? *Journal of Economic Surveys* 15(3):433–60.
- Hanley, N., R. Wright, and V. Adamowicz. 1998. Using choice experiment to value the environment. *Environmental and Resource Economics* 11(3–4):413–28.
- Hansen, T. 1997. The willingness to pay for the Royal Theatre in Copenhagen as a public good. *Journal of Cultural Economics* 21(1):1–28.
- Harless, D. W., and F. R. Allen. 1999. Using the contingent valuation method to measure patron benefits of reference desk service in an academic library. *College and Research Libraries* 60(1):56–69.
- Hausman, J. A., and P. A. Ruud. 1987. Specifying and testing econometric models for rank ordered data. *Journal of Econometrics* 34:83–104.
- Hensher, D. A. 1994. Stated preference analysis of travel choices: The state of practice. *Transportation* 21:107–133.
- Hensher, D. A., and L. W. Johnson. 1974. *Applied Discrete Choice Modeling*. London: Halsted Press.
- Hett, T., and S. Mourato. 2000. Sustainable management of Machu Picchu: A stated preference approach. Department of Environmental Science and Technology, Imperial College of Science, Technology, and Medicine, London. Mimeograph.
- Holt, G. E., D. Elliott, and A. Moore. 1999. Placing a value on public library services. *Public Libraries*, pp. 98–108.
- Hutchinson, G. 1996. Threats to underwater cultural heritage: The problems of unprotected archaeological and historic sites, wrecks, and objects found at sea. *Marine Policy* 20(4):287–90.
- Kahneman, D., I. Ritov, and D. Schkade. 1999. Economic preferences or attitude expressions?: An analysis of dollar responses to public issues. *Journal of Risk and Uncertainty* 19(1–3):203–235.
- Kahneman, D., and R. Thaler. 1991. Economic analysis and the psychology of utility: Applications to compensation policy. *American Economic Review* 81(2):341–46.
- Kenkel, D., R. Fabian, and G. Tolley, eds. 1994. *Valuing Health for Policy: An Economic Approach*. Chicago: University of Chicago Press.

- Kling, R., C. Revier, and K. Sable. 2000. Estimating the public good value of preserving a local historic landmark: The role of non-substitutability and information in contingent valuation. Paper presented to the Association for Cultural Economics Conference, Minneapolis.
- Lancaster, K. 1991. *Modern Consumer Theory*. Cheltenham, U.K.: Edward Elgar.
- London Economics. 1999. *The Environmental Costs and Benefits of the Supply of Aggregates*. Phase 2. London: Department of the Environment, Transport and the Regions.
- Louviere, J., D. Hensher, and J. Swait. 2000. *Stated Choice Methods: Analysis and Application*. Cambridge: Cambridge University Press.
- McFadden, D. 1999. Rationality for economists? *Journal of Risk and Uncertainty* 19(1-3):73-105.
- Maddison, D., et al. 1996. *Blueprint 5: The True Costs of Road Transport*. London: Earthscan.
- Maddison, D., and T. Foster. 2001. Valuing congestion in the British Museum. Department of Economics, University College London. Mimeograph.
- Maddison, D., and S. Mourato. 2002. Valuing different road options for Stonehenge. *Journal of the Conservation and Management of Archaeological Sites* (in press).
- Malhotra, N. 1999. *Marketing Research: An Applied Orientation*. 3rd ed. Upper Saddle River, N.J.: Prentice Hall.
- Martin, F. 1994. Determining the size of museums subsidies. *Journal of Cultural Economics* 18(4):255-70.
- Mitchell, R., and R. Carson. 1989. *Using Surveys to Value Public Goods: The Contingent Valuation Method*. Washington, D.C.: Resources for the Future.
- Morey, E., et al. 1997. Valuing acid deposition injuries to cultural resources. Report for the National Acid Precipitation Assessment Program.
- Mourato, S., et al. 2001. Beyond dusty archives: The economic benefits of preserving recorded heritage. *Cultural Trends* 39:85-116.
- Mourato, S., A. Kontoleon, and A. Danchev. 2002. Preserving cultural heritage in transition economies: A contingent valuation study of Bulgarian monasteries. In *Valuing Cultural Heritage: Applying Environmental Valuation Techniques to Historic Buildings, Monuments, and Artifacts*, ed. S. Navrud and R. Ready. Cheltenham, U.K.: Edward Elgar.
- Navrud, S., P. Pedersen, and J. Strand. 1992. Valuing our cultural heritage. A contingent valuation survey. Centre for Research in Economics and Business Administration, Oslo, Norway.
- Navrud, S., and R. Ready, eds. 2002. *Valuing Cultural Heritage: Applying Environmental Valuation Techniques to Historic Buildings, Monuments, and Artifacts*. Cheltenham, U.K.: Edward Elgar.
- Nuti, F. 1998. Paternalism vs. consumer sovereignty. In *Environmental Resource Evaluation: Applications of the Contingent Valuation Method to Italy*, ed. R. C. Bishop and D. Romano. Amsterdam: Kluwer Academic Publisher.
- Pagiola, S. 1999. Valuing the benefits of investments in cultural heritage: The historic core of Split. Paper presented at the World Bank Economists' Forum, Alexandria, Va., May 3-4.
- Pearce, D. W. 1993. *Economic Values and the Natural World*. London: Earthscan.
- Pearce, D. W., and S. Mourato. 1998. *The Economics of Cultural Heritage: World Bank Support to Cultural Heritage Preservation in the MNA Region*. Washington, D.C.: World Bank.
- Pearce, D. W., D. Whittington, and S. Georgiou. 1994. *Project and Policy Appraisal: Integrating Economics and the Environment*. Paris: OECD.
- Pollicino, M., and D. Maddison. 2001. Valuing the benefits of cleaning Lincoln Cathedral. *Journal of Cultural Economics* 25(2):131-48.
- Powe, N. A., and G. K. Willis. 1996. Benefits received by visitors to heritage sites: A case study of Warkworth Castle. *Journal of Environmental Planning and Management* 15(5):611-19.
- Riganti, P., and K. Willis. 1998. Categorical nesting and temporal reliability of estimates for complex historic goods. Paper presented at the World Congress of Environmental and Resource Economists, Venice, June.
- Robbins, L. 1938. *Political Economy: Past and Present*. London: McMillan.
- Roche Rivera, H. 1998. The willingness to pay for a public mixed good: The Colón Theatre in Argentina. Paper presented at the Tenth International Conference on Cultural Economics, Barcelona, 14-17 June.
- Rosen, S. 1974. Hedonic prices and implicit markets: Production differentiation in pure competition. *Journal of Political Economy* 82:34-55.
- Santagata, W., and G. Signorello. 2000. Contingent valuation and cultural policy design: The case of Napoli Musei Aperti. *Journal of Cultural Economics* 24(3):181-204.
- Satterfield, T., P. Slovic, and R. Gregory. 2000. Narrative valuation in a policy judgment context. *Ecological Economics* 34(3):315-31.
- Scarpa, R., G. Sirchia, and M. Bravi. 1997. Kernel vs. Logit modelling of single bounded cv responses: Valuing access to architectural and visual arts heritage in Italy. In *Environmental Resource Evaluation: Applications of the CVM to Italy*, ed. R. C. Bishop and D. Romano. Amsterdam: Kluwer Academic Publisher.
- Scott, A. 1965. *The Valuation of Game Resources: Some Theoretical Aspects*. Canadian Fisheries Report No. 4. Department of Fisheries of Canada, Ottawa, Ontario.
- Steiner, F. 1997. Optimal pricing of museum admission. *Journal of Cultural Economics* 21(4):307-33.
- Throsby, D. 2001. *Economics and Culture*. Cambridge: Cambridge University Press.
- Throsby, D., and G. Withers. 1985. What Price Culture? *Journal of Cultural Economics* 9(2):1-34.
- Tversky, A., and D. Kahneman. 1982. The framing of decisions and the psychology of choice. In *Question Framing and Response Consistency*, ed. R. Hogarth. San Francisco: Jossey-Bass.
- UNESCO. 1972. *World Heritage Convention*. N.p.: UNESCO.

- Vatn, A., and D. W. Bromley. 1995. Choices without prices without apologies. In *The Handbook of Environmental Economics*, ed. D. W. Bromley. Cambridge: Blackwell Publishers.
- Vaughan, D. R. 1984. The cultural heritage: An approach to analyzing income and employment effects. *Journal of Cultural Economics* 8(2):1-36.
- Whitehead, J., C. Chambers, and P. Chambers. 1998. Contingent valuation of quasi public goods: Validity, reliability, and application to valuing a historic site. *Public Finance Review* 26:137-54.
- Willis, K. G. 1994. Paying for heritage: What price for Durham Cathedral? *Journal of Environmental Planning and Management* 37(3):267-77.
- World Bank. 1994. *Social Assessment: Incorporating Participation and Social Analysis into the Bank's Operational Work*. Washington, D.C.: World Bank.

Appendix 1 Overview of Stated-Preference Studies of Cultural Goods

Authors	Cultural Asset	Type of Value	WTP (US\$)	WTP Definition <sup>1</sup>	% Zero WTP <sup>2</sup>	Sample Size <sup>2</sup>
Maddison and Mourato 2002	Stonehenge, UK	Value of the impacts of road improvements	20-23 (on-site, nationals) 6-11 (off-site, nationals) 0.3-2 (on-site, foreigners)	Household, annual (2 years), PC/CM, tax (nationals)/entry fee (foreigners)	55 (nonusers) 65 (approx.)	271 (nationals on-site), 525 (nationals off-site), 116 (foreign on-site)
Mourato, Kontoleon, and Danchev 2002	Bulgarian monasteries	Value of preservation	0.6-1.00	Household, annual, OE, tax	39	487 (all Bulgarians)
Pollicino and Maddison 2001	Lincoln Cathedral, UK	Value of aesthetic changes due to air pollution	1-2 (per year of soiling)	Household, annual, DC, tax	19 (approx.)	328 (Lincolnshire residents)
Mourato et al. 2001	Surrey History Centre, UK	Total value	29 (users) 14.5 (nonusers)	Household, annual, PC, tax	3	60 (pilot)
Mourato et al. 2001	Hulton Getty Picture Library, UK	Value of preventing deterioration	7 (nonusers)	Household, annual, PC, tax	11	35 (pilot)
Maddison and Foster 2001	British Museum, UK	Congestion costs	9	Individual, per visit, CM, entry fee	n.a. <sup>2</sup>	400
Santagata and Signorello 2000	Napoli Musei Aperti, Italy	Total value	11 (users) 4 (nonusers)	Individual, annual, OE/DC, donation	34 (users) 67 (nonusers)	468 (Naples residents)
Hett and Mourato 2000	Machu Picchu, Peru	Value of access	26-47 (Citadel) 35-62 (Inca Trail) 6 (cable car)	Individual, per visit, PC, entry fee	None	711 (Citadel), 303 (Inca Trail)
Dixon 2000	Petra and Wadi Rum, Jordan	Market price analysis	48 (Petra) 14 (Wadi Rum)	Individual, per visit of 1.25 days, DC, economic rent	n.a.	n.a.
Kling, Revier, and Sable 2000	Northern Hotel, Fort Collins, USA	Preservation value	86-126 (tax, low-high information) 195-434 (forgone rebate, low-high information)	Household, one-time, DC, tax/forgone rebate	n.a.	n.a.
Holt, Elliott, and Moore 1999	St. Louis public libraries, USA	Total value	4	Household, annual, OE, tax	n.a.	236 (public), 75 (teachers), 25 (business)
Harless and Allen 1999	Cabell Library, Virginia Commonwealth University, USA	Total value of reference desk services and value of additional hours	11-46 (students/staff, current hours) 1-9 (students/staff, additional hours)	Individual, annual, OE, tuition and fees	5	170 (students), 212 (staff)

Authors	Cultural Asset	Type of Value	WTP (US\$)	WTP Definition <sup>1</sup>	% Zero WTP <sup>2</sup>	Sample Size <sup>2</sup>
Pagiola 1999	Historic core of Split, Croatia	Value of restoration	44 (domestic and foreign tourists) 168 (local residents)	Individual, per visit (tourists), individual, annual (residents), DC, tax	n.a.	n.a.
Coulton 1999	Prehistoric cave paintings, Peak District, UK	Preservation value	1 (more access, less preservation) 14 (less access, more preservation)	Individual, one-time, OE, tax	85 29	n.a.
Bolling and Iversen 1999	Stone Town, Zanzibar	Value of restoration	20 (tourists)	Individual, per visit, OE / DC, arrival fee	n.a.	n.a.
Whitehead, Chambers, and Chambers 1998	St. Genevieve Academy, Missouri, USA	Preservation value	5-6	Individual, one-time, PC, donation	61	132 (Missouri residents)
Roche Rivera 1998	Colón Theatre, Buenos Aires, Argentina	Value of rehabilitation	58	Individual, annual, DC, tax	67	3,036 (Buenos Aires residents)
Riganti and Willis 1998	Campi Flegrei archaeological park, Naples, Italy	Value of conservation	216	Individual, annual (5 years), DC, donation	18 (approx.)	480 and 422 (city residents)
Boxall, Englin, and Adamowicz 1998	Aboriginal rock paintings, Nopiming Park, Canada	Recreational value of pristine and defaced travel cost	3-5 (pristine) 0.3-0.4 (defaced)	Individual, per trip, CM, travel cost	58	386 (visitors)
Carson et al. 1997	Fes Medina, Morocco	Non-Moroccan value of rehabilitation	38-70 (Fes visitors) 22-31 (Morocco visitors) 6-17 (Europe nonvisitors)	Individual, per trip (visitors) / one time (nonvisitors), DC, tax	17 (approx.) 19 (approx.) min. 15	471 (Fes visitors), 126 (Morocco visitors), 30 (experts)
Morey et al. 1997	Monuments in Washington, D.C.	Value of acid deposition injuries	16 (low impact) 23 (medium impact) 33 (high impact)	Household, one-time only, CM, none	8 (approx.)	272 (northeastern U.S. population)
Scarpa, Sirchia, and Bravi 1997	Rivoli Castle, Italy	Valuing the right to access at present charges	28-33	Individual, annual, DC, donation	18 (approx.)	1,323 (visitors)
Beltran and Rojas 1996	Mexican archaeological sites	Value of access and preservation	1-2.5 (visitors) 1.5-2 (city residents)	Individual, per visit, BG, entry fee	n.a.	900 (visitors), 5,603 (city residents)
Garrod et al. 1996	Historical buildings in Grainger City, Newcastle, UK	Value of renovation	16-22	Household, annual, OE, tax	47	217 (city residents)
Powe and Willis 1996	Warkworth Castle, UK	Value of visitor benefits	4	Individual, per visit, OE, fee	n.a.	201 (visitors)
Hansen 1997	Royal Theatre, Copenhagen	Value of continuing current activities	9-24	Individual, annual, OE, tax	18	1,843 (Danes)

Authors	Cultural Asset	Type of Value	WTP (US\$)	WTP Definition <sup>1</sup>	% Zero WTP <sup>2</sup>	Sample Size <sup>2</sup>
Willis 1994	Durham Cathedral, UK	Value of access	1.4	Individual, per visit, OE, fee	36	92 (visitors)
Grosclaude and Soguel 1994	Historical buildings, Neuchâtel, Switzerland	Damages from traffic-caused air pollution	77–86	Individual, annual, BG, donation	43	200 (city residents)
Martin 1994	Musée de la Civilisation, Québec, Canada	Total value of Québec museum	8	Individual annual, OE, tax	n.a.	1,231
Navrud, Pedersen, and Strand 1992	Nidaros Cathedral, Norway	Damages from air pollution	51 (originals preserved) 45 (restoration losing originals)	Individual, annual, OE, n.a.	n.a.	163 (visitors)
Throsby and Withers 1985	Theater, opera, ballet, music, visual arts, and crafts, Sydney, Australia	Value of arts support	18–111	Individual, annual, OE, tax	n.a.	827 (city residents)

1. DC = dichotomous choice, OE = open ended, BG = bidding game, PC = payment card, CM = choice modeling.

2. n.a. = not available.



# Numbness and Sensitivity in the Elicitation of Environmental Values

By Theresa Satterfield

THERE ARE MYRIAD DEFINITIONS of value both colloquial and formal. This paper takes stock of recent work by social scientists and ethicists on the subject of environmental values. Its foremost purpose is to highlight the central features of scholarly efforts to (a) articulate the environment-centered values characteristic of different social groups, and (b) operationalize environmental values in the context of policy decisions about land management. Its secondary purpose is to cull from this literature a few central tensions and problems encountered in the study of environmental values. It is hoped that any derived insights will be useful not just to the evaluation of environmental goods but to scholars concerned with the value-based assessment of cultural heritage and the practice of heritage conservation. I will begin with a review of several exemplary and seminal studies. Then I will address emergent critiques of conventional practices and the exploratory methods that such critiques have inspired. The paper closes with a few recommendations and questions that all valuation practices need address.

---

## Valuing the Environment

The last decade has witnessed a flurry of research aimed at identifying the value of nature (broadly construed), specific environmental goods (a northern spotted owl), or cherished places (Yellowstone National Park). Contributions to the literature have been generated from most corners of the natural, economic, social, psychological, political, and decision sciences, as well as from philosophy, from which has emerged the subdiscipline of environmental ethics. Some have sought methods that reflect axiomatic definitions of value, while others assert the importance of relativistic or subjective approaches. Some make distinctions between held values (beliefs we adhere to), while others focus on assigned values (rankings or numeric tags that express the relative weight of one value as compared to one or more different values). Others still are concerned with the proper representation of values that are not only tangible (e.g., those based on the specific physical

attributes of a good) but also intangible (e.g., those based on more nebulous qualities, such as the ability to inspire awe or the ability to symbolize revered spiritual or cultural properties). In addition, many (though not all) of these approaches seek to provide alternatives to dollar-centric definitions of value. Of particular concern is the use by economists of contingent valuation (cv) methods wherein an individual's (hypothetical) market preference (i.e., "value" for) a natural good is ascertained by asking stakeholders or survey respondents to state how much they would be willing to pay to improve the status of a particular environmental good—for example, to improve the habitat of an endangered species.

Two broad-stroke (though not necessarily consciously articulated) positions underpin much of the values literature. The first can be characterized as axiomatic. An axiomatic, or maxim-focused, approach operates on the premise that certain categories of value are better, "truer," more important, more self-evident, and/or more intellectually defensible than all others. Such prioritized values should, as is implied or asserted, provide the basis from which environmental policy is derived. Axiomatic traditions are, by definition, expert driven. Determining higher-order values is achieved by assessments, arguments, or measurements produced by disciplinary specialists who are not necessarily attendant to the opinions of stakeholders or nonspecialists. The second position—an antiaxiomatic, or relativistic, one—is guided by the principle of cultural or intersubjective relativism. The point for these practitioners is that there are no right or wrong value positions, only different ones. Researchers are expected to elicit but not judge or influence these disparate perspectives during the elicitation process. Their findings are used to provide insight to those responsible for making land management decisions or setting environmental policy.<sup>1</sup>

## **Axiomatic Traditions in Environmental Ethics**

A rich body of axiomatic work on the subject of environmental values can be attributed to environmental ethicists. Ethics—in this case environmental ethics—are defined as the putting into practice of notions of “right” versus “wrong” conduct toward nature (Armstrong and Botzler 1993; Proctor 1996; Rolston 1999). Environmental ethicists have considered, therefore, the philosophical basis for assigning value (and thus right practice) by arguing for different instrumental and, importantly, intrinsic moral values embodied in nature (and/or its component parts). Due to consciousness, only humans are moral agents (and thus can evaluate things); ecosystems, organisms, and species can nonetheless be defended as possessing certain kinds of value in and of themselves (Callicott 1984, 1986, 1995; Nash 1989; Norton 1991; Rolston 1988, 1994; Sagoff 1988, 1991; Stone 1987).

Among the ethical divisions central to this literature is that between anthropocentric versus biocentric positions (Callicott 1995; Norton 1991; Rolston 1994, 1999). An anthropocentric ethic posits that nature’s worth is derived primarily from its capacity to serve human ends. A biocentric ethic respects all living organisms; because nature is alive, it is regarded as “good” in its own right and thus deserving of moral consideration. Many nuanced arguments exist within these broad-stroke positions—for example, whether it is better to inculcate an environmental ethic based on the potential human benefits of a healthy environment (Norton 1986), on the argument that nature has rights and thus its welfare should be taken into account or enshrined in law, on the aesthetic attributes of nature, on the basis of a cross-human and human-to-nature ethic of egalitarianism, and so on (Merchant 1992). These considerations, in turn, raise several questions about humans’ obligatory posture toward nature—namely, what are our obligations to the natural environment? And are those obligations derived from our obligations to ourselves and other humans, or are they derived from a discrete obligation to nature (Dickson 2000)?

Regardless of any one ethicist’s position on the above points, most agree that the values or attitudes human beings hold about nature are the root cause of environmental problems. There is a fundamentally ideational argument. It is assumed that current value systems reflect our disregard for nature and even our willingness to dominate nature (a position typically attributed to the Judeo-Christian tradition), which in turn legitimizes

or causes our heedless exploitation of natural systems. It is further assumed that if people adopt a more ethical orientation toward the environment, environmental problems will in part be solved (Dickson 2000, 127).

Despite a prodigious scholarly output in recent years, very few ethicists have put forth specific value typologies or rankings of higher- to lower-order values. The field is concerned, instead, with exploring the moral arguments for and behavioral implications of specific ethics when put into service in multiple (applied) contexts. Two of the more compelling examples include the *land ethic* and the *naturalness* principle. The land ethic, first invoked by forester and philosopher Aldo Leopold and the basis of much modern ecology, stipulates that (a) our definition of community should be extended to include the biotic community—that is, to soil, water, plants, animals, or, collectively, the land—and (b) that to destroy any one part is to threaten the whole, humanity included (Leopold 1966). Because the loss of any one (ecosystemic) part threatens the whole, ultimate value is placed on maintaining system integrity. One must keep all the parts of a healthy system. Hence, the conservationists’ motto aimed at avoiding irreversible ecological damage: the first rule of intelligent tinkering is to keep all the parts.

Conserving natural value as the highest-order value proposes, alternately, that species and ecological systems be maintained in a form that best replicates their state in nature as it would be in the absence of significant human intervention (Rolston 1994).<sup>2</sup> A park ranger following a natural wildlife ethic would not, therefore, attempt to rescue a bison falling through the ice. The bison would be left to manage the predicament alone. But the ranger would intervene to save fauna injured by park motorists, as there is nothing “natural” about a car traveling through wildlife habitat at sixty miles per hour.<sup>3</sup>

## **Axiomatic Traditions—Ecological Values**

A second, very significant contribution to axiomatic methods for identifying environmental values is driven by the work of ecologists. Scientists generally think of their work as value free, and in this sense, they do not conceive of their work as axiomatic. But their efforts are, nevertheless, expert driven, and their conclusions are suggestive of practices that are themselves axiomatically defended. The value of environmental goods for this group of scholar-evaluators is assessed on the basis of their contribution to the functioning of the overall system and/or for the importance attributed to particular ecosystem service

(e.g., the provision of clean water). For modeling and assessment purposes, emphasis is typically placed on indicators of system integrity, health, carrying capacity, or resilience. This practice can point in turn to the designation of critical habitat or draw attention to (i.e., valorize) system functions—for instance, the waste-filtering capacities of wetlands or the importance of a keystone species to the overall health of a system. A central question for most of these approaches is: What is the best indicator of overall health, and/or Which indicators speak to which components of a system—be that at the level of organisms; whole populations; or the larger forest, tropical, desert, or other ecosystems of which these are a part (Suter 1993).

Prominent among the efforts by ecologists to valorize ecosystem services is the adoption by Costanza and colleagues of the economists' penchant for market expressions of value. "The Value of the World's Ecosystem Services and Natural Capital" was published first in the journal *Nature* and subsequently in the journal *Ecological Economics* (Costanza et al. 1998). The paper contains a typology of worth based on the economic contribution (or the "total global flow of \$ value per year") of different geographic domains (marine, riverine /lake, terrestrial, wetland, grassland, desert, tundra, urban, etc.). Each domain is examined for its contribution to specific ecosystem services (e.g., gas regulation, climate regulation, water supply, nutrient recycling, etc.). The authors' breakdown of services is a viable schema of ecologists' thinking on values, whereas the attention their findings draw to the functions of nature normally taken for granted is oft cited. A summation of these features is characterized in Table 1.

The concluding assessment by Costanza and colleagues that the total global biosphere is worth, on average, \$33 trillion per year (nearly twice the annual gross national product of the United States) has, however, been very controversial. Many economists working to elicit dollar value as a measure of and a means for ranking public preferences for natural goods view the authors' costing of the globe as a slight to their disciplinary integrity. Ecocentric-leaning ecologists, meanwhile, remain ill at ease with Costanza and colleagues' preoccupation with human- and market-centric (i.e., capital-worth) perspectives as the basis for environmental valuation.

Regardless, ecologists and, to a greater extent, ethicists labor to argue that nature is typically undervalued and that—if we become more fully cognizant of the moral qualities as well as of the material, aesthetic, and spiritual benefits of nature—nature might come to be managed by humans with respect and according to a range of axiomatic principles. They valorize certain qualities of natural systems, attributes regarded as overlooked in a post-World War II era that prioritizes the extraction of renewable and nonrenewable natural resources.

**Table 1** Summary of average global value of annual ecosystem services. (Source: Adapted from "The Value of the World's Ecosystem Services and Natural Capital," by R. Costanza, R. d'Arge, R. de Groot, S. Farber, M. Grasso, B. Hannon, S. Naeem, K. Limburg, J. Parnelo, R. V. O'Neill, R. Raskin, P. Sutton, and M. van den Belt, 1997, *Nature* 387, p. 254. Copyright 1997 by Nature Publishing Group. Adapted with permission.)

Ecosystem Services	Total Global Flow Value (\$/year <sup>-1</sup> x 10 <sup>9</sup> )
Gas regulation	1,341
Climate regulation	684
Disturbance regulation	1,779
Water regulation	1,115
Water supply	1,692
Erosion control	576
Soil formation	53
Nutrient cycling	17,075
Waste treatment	2,277
Pollination	117
Biological control	417
Habitat refugia	124
Food production	1,386
Raw materials	721
Genetic resources	79
Recreation	815
Cultural	3,015
<b>Total</b>	<b>33,268<sup>1</sup></b>

1. In trillions of dollars, for a total of \$33 trillion, \$268 billion.

## Relativistic Traditions

Ethicists and ecologists have forced onto the values stage the relevance of both a systemic / functional and a morally resonant definition of value. The cross-fertilization with other disciplines of these ideas is ongoing and significant, some of which will become apparent below. It remains the case, however, that the study of environmental values for policy and land management purposes is heavily influenced by relativistic approaches or, more colloquially, by practitioners whose central goal is the monitoring of public opinion. This relativistic slant is partly because of the deep tradition across the social sciences of “value-neutral” approaches to human behavior and partly because “the individual being is seen, for all practical purposes, as the originator of preference and, therefore, of value” (Brown 1984, 231). It is also because of the role citizen preferences play in the instigation of endangered species legislation, the growth of environmental activism, and the general public support for environmentally oriented behavior (recycling, water conservation, wilderness recreation, green consumerism, etc.). More important, considerable support exists today for public consultation as the basis of good governance and civil society.

Following Brown and Gregory, most of the available social science valuation tools are glossed as expressed preference approaches (Brown 1984; Gregory 1999). “Preference is used here to mean the setting by an individual of one thing before another because of a notion of betterness” (Brown 1984, 232–34). This overarching category can be subdivided further still into approaches that work to identify held values (underlying values or ideals that prioritize modes of conduct and desirable qualities) and those that work to measure assigned values (the relative importance or worth of an object in a given context, which is not a characteristic of the object per se but the importance of which is derived, at least partially, from held values). Understandably, much confusion for new students of environmental values is generated by the failure of many practitioners to clarify whether one is talking about held or assigned values. (To confuse the matter further, held values can be converted to assigned values in that they can be ranked as more or less important relative to one another. Furthermore, norms overlap with held values to the extent that a norm is a value that one asserts as more important than others, as something that one should do or act in accordance with, versus something that one enduringly believes matters.)

## Contingent Valuation as Willingness to Pay

As implied above, expressed preference work is dominated by contingent valuation surveys employing willingness-to-pay (WTP) and willingness-to-accept (WTA) protocols (Mitchell and Carson 1989).<sup>4</sup> Resting on the economists’ assumption that dollars are as neutral a metric for measuring value as is available, practitioners posit a hypothetical market on which environmental improvements and losses are exchanged for promised payment. It is further assumed that preference is akin to the pursuit of individual human welfare or self-interest played out as a rational market choice. Participant-citizens in WTP/WTA studies are asked to state the maximum price they would be willing to pay to obtain an improvement in environmental quality (e.g., a restored bird habitat) or to state the price they would be willing to accept given deterioration of status (e.g., loss of said habitat). Requests to assign dollar values to such environmental goods are generally accompanied by technical information on the geophysical domain (e.g., a community watershed) in question and quantitative details about the benefits (perhaps recreational or ecological) and costs (perhaps jobs lost or revenues forgone) of different policy options. Total WTP is the product of average or mean WTP multiplied by the population to which the decision applies (a local town, users of an environmental asset, a county, a nation-state, etc.). Total WTP is then pitted, in a cost-benefit analysis, against the costed interests of other stakeholders (industry, government, competing resource users, etc.).

## Psychological and Social Studies of Value

Dissatisfaction with economic definitions of value and a strong tradition in the study of attitudes and beliefs in sociology and psychology have helped fuel many alternate nonmonetary studies of value. Most of this work emphasizes a “values held” definition. Much of it also recognizes the escalation of environmental concern over time and across social groups and finds that values once thought extremely radical are held by a broad variety of individuals and groups (Dunlap and Scarce 1991). More important, this body of work disavows (a) the assumption that, taken literally, values and valuation are synonymous, that quantitative values equal, or actually express, one’s values, and (b) the assumption that the public majority endorses and is satisfactorily portrayed by rational, economic expressions of the value of nature. Most define

**Table 2** Responses to new environmental paradigm (NEP) scale items by the general public sample (GPS) and the environmental organization sample (EOS). (Source: Adapted from “The ‘New Environmental Paradigm,’” by R. E. Dunlap and K. D. Van Liere, *Journal of Environmental Education* 9 (1978), no. 4, pp. 10–19. Reprinted with permission of the Helen Dwight Reid Education Foundation. Published by Heldref Publications, 1319 8th Street NW, Washington, D.C. 20036-1802. Copyright © 1978.)

Statement	Agreement in GPS (%)	Agreement in EOS (%)
1. We are approaching the limit of the number of people the earth can support.	73.0	93.1
2. The balance of nature is very delicate and easily upset.	80.1	93.4
3. Humans have the right to modify the natural environment to suit their needs.	38.1	20.2
4. Mankind was created to rule over the rest of nature.	46.5	7.7
5. When humans interfere with nature, it often produces disastrous consequences.	76.2	92.2
6. Plants and animals exist primarily to be used by humans.	38.6	7.9
7. To maintain a healthy economy, we will have to develop a “steady-state” economy, where industrial growth is controlled.	69.9	91.6
8. Humans must live in harmony with nature in order to survive.	95.6	99.0
9. The earth is like a spaceship with only limited room and resources.	83.1	99.0
10. Humans need not adapt to the natural environment because they can remake it to suit their needs.	15.4	4.3
11. There are limits to growth beyond which our industrialized society cannot expand.	75.3	93.1
12. Mankind is severely abusing the environment.	79.0	98.0

value as “what we care about” (Keeney 1992, 3), as the “basic motivations which guide thoughts and action” (Axelrod 1994, 83), or, following Rokeach, as general goals or orienting dispositions from which attitudes to specific items are derived (Rokeach 1973; Stern et al. 1995).

Recall that the principal distinction between relativistic and axiomatic studies is that for the first group, the goal is to characterize the values held (and for WTP, assigned) by the public, while for the second group, the goal is to instantiate the wisdom of recognizing some values as more important or significant than others and, in so doing, overturn the historical force of a human-centric, utilitarian worldview that promotes human arrogance toward and dominance over nature. Yet the salient feature of three classic nonaxiomatic studies of value is the decidedly ecocentric flavor detected in survey responses.

As early as 1978, Dunlap and Van Liere argued convincingly that a “new environmental [value] paradigm” (NEP) was emerging to supplant the dominant social paradigm (DSP) (Dunlap and Van Liere 1978). The DSP is that “constellation of values, attitudes, and beliefs” thought to underpin key Western assumptions about the

human-nature interface (i.e., the beliefs that limitless progress is possible, that faith in science and technology is abundant, that nature exists to serve humans, etc.). The NEP measures include twelve statement items with either a pro- or antienvironmental cast; topically, the items explore the tolerance expressed for limits to growth, support for a greater balance between the human and nonhuman world, and support for antianthropocentric positions (Table 2). Salient among Dunlap and Van Liere’s findings is the “remarkable degree of acceptance of the NEP—not only among environmentalists, which was expected, but among the general public as well” (Dunlap and Van Liere 1978, 12).

Equally renowned (with conclusions not unlike Dunlap and Van Liere’s) is Stephen Kellert’s broadly cross-cultural survey work, much of which is summarized in his book *The Value of Life* (Kellert 1996). Humans universally recognize, argues Kellert, the importance of biodiversity to their physical, emotional, spiritual, and intellectual well-being. Relying on studies conducted in several North American, European, Asian, and African nation-states, Kellert argues that we are by nature biophilic—that is,

**Table 3** *A typology of basic values.* (Source: From *The Value of Life: Biological Diversity and Human Society*, by Stephen R. Kellert. Copyright © 1996, Island Press. Reproduced by permission of Island Press/Shearwater Books, Washington, D.C., and Covelo, California. All rights reserved.)

Value	Definition	Function
Utilitarian	Practical and material exploitation of nature	Physical sustenance/security
Naturalistic	Direct experience and exploration of nature	Curiosity, discovery, recreation
Ecologicistic-scientific	Systematic study of structure, function, and relationship in nature	Knowledge, understanding, observational skills
Aesthetic	Physical appeal and beauty of nature	Inspiration, harmony, security
Symbolic	Use of nature for language and thought	Communication, mental development
Humanistic	Strong emotional attachment and “love” for aspects of nature	Bonding, sharing, cooperation, companionship
Moralistic	Spiritual reverence and ethical concern for nature	Order, meaning, kinship, altruism
Dominionistic	Mastery, physical control, dominance of nature	Mechanical skills, physical prowess, ability to subdue
Negativistic	Fear, aversion, alienation from nature	Security, protection, safety, awe

predisposed to appreciate the nonhuman world, an appreciation he regards as rooted in nine core value orientations (Table 3). These nine values, considered biological in origin, signify basic structures of human relationship and adaptation to the natural world developed over the course of human evolution. Edward O. Wilson conceived the term *biophilia* to describe the deep biological need for affiliating with life and nature. The nine values are thought to reflect a range of physical, emotional, and intellectual expressions of the biophilic tendency to associate with nature (Kellert 1996, 26).

Culture, history, and human experience may differently shape the salience of these values across populations. Further, Kellert is careful to assert that his categories are labels of convenience and that he does not mean to indicate their order of importance. Humanistic values may be more widely endorsed by Americans than utilitarian ones, but that is not to say that Kellert is himself promoting the significance of one orientation above another (Kellert 1996, 10, 41).

Some scholars disagree with Kellert’s assumptions about biological or biophilic predispositions. They may also find difference where Kellert finds universality—to wit, they interpret the ethnic-, income-, and gender-driven differences uncovered in his book as more meaningful than does Kellert. His typology is, nonetheless, consistent with a number of subsequent studies (e.g., Steel et al. 1993) and is supported, equally, by work in other disciplines.

Two final well-known contributions to the field are Stern and Dietz’s work on the value basis of environmental concern and Kempton and colleagues’ work on the intersection of cultural models and environmental values (Stern and Dietz 1994; Kempton, Boster, and Hartley 1995). Stern and Dietz isolate those values most closely associated with the preservation of nature and environmentalism generally. Upon factor analysis of numerous attitudinal statements, a tripartite value schema emerged composed of egoistic, altruistic, and biospheric value orientations. The first category distinguished some people as self-interested maximizers, the second as concerned primarily with the costs and benefits carried by others (altruistic), and the third as concerned with the costs and benefits posed for the biosphere as a whole (biospheric). Kempton, Boster, and Hartley similarly found that most values could be attributed to, or were deeply rooted in, religious thought, utilitarian and human-centric self-interest, and a biocentric belief in the rights of nature and species (Kempton, Boster, and Hartley 1995).<sup>5</sup> They also found that such values were inseparable from lay theories or models about the causes of environmental problems (in their case, global warming). That is, study participants were easily drawn to and persuaded by causal explanations (however accurate or erroneous) most closely articulated with their values orientations.

---

## **Cognitive Difficulties and Moral Conundrums in the Development of Valuation Practices**

The above contributions to the social and psychological dimensions of value have legitimized a much broader conception of the term *value* than was heretofore common in the field of environmental valuation. Social scientists have provided evidence for the claim that expressions of value are rooted both in utilitarian approaches to preference (which address the question What is it that a person values or will “pay for” because it benefits him or her as an individual?) and in ethical and deontological approaches (which address the question What does a person believe to be important to the greater good that is nature and society?) (Sagoff 1998). The enormous advances in value identification techniques offered by these seminal studies cannot be underestimated. However, as researchers, decision makers, and policy advisors look for ever deeper understandings of value, and for greater clarification as to how values influence decision making, a new set of criticisms (and a new set of research directions) has emerged. The next section addresses these criticisms, in particular (a) the cognitive limitations that most persons exhibit when facing a value-based decision problem, (b) the inability to link values and actions, and (c) the fact that the language and context in which values are elicited still serves to silence many ethical values and moral concerns. The next section examines this author’s recent experiments with tools aimed at addressing both cognitive and ethical variables.

### **Cognitive Difficulties**

The study of environmental values is increasingly influenced by the work of psychologists and decision analysts, who have found, overwhelmingly, that peoples’ cognitive ability is bounded. This bounding is due not to lack of wisdom per se; it is simply the case that everyone has difficulty navigating through the complexities involved in making judgments about value or in making decisions. The inability to manage that complexity intellectually is attributed to features of human cognition. Namely, problems arise because people routinely and unconsciously avert complexity by relying on a consistent set of biases or “heuristics” (rules of thumb) that make information processing easier and simplify decisions. Such heuristics and biases can be an elegant means to an efficient decision, but in many cases, they lead to errors or

poor-quality judgments. Cognitive difficulty can also be attributed to the features of the decision task itself. Most value studies work to identify the links between values held and the decision or policy that such values support, but it turns out that standard surveys offer relatively poor opportunities for respondents to think through the links between a value stated and an action endorsed. Together these difficulties suggest that how a value is elicited—the way in which a valuation task is set up, worded, or *framed*—strongly influences the outcome.

### **Framing Effects**

Prominent examples of framing effects follow.<sup>6</sup>

- *The availability heuristic*, which finds that people estimate the frequency of the occurrence of something on the basis of how easily they can imagine or recall an instance of it. Vivid examples (e.g., the prospect of a wildfire or the thought of a charismatic species) leave us fixated on single aspects of a decision problem or cause us to underestimate the importance of less-familiar aspects of the problem.

- *Gain/loss effects*, which find that questions worded in an apparently equivalent manner are not always perceived as such. For example, questions framed as gains versus losses can have an unintended effect on the outcome of a valuation task, because people tend to react more strongly to the thought of a loss than to the thought of a gain. As a result, higher WTP scores will be attributed to the recovery from a loss of ten acres of a wetland than to the gain of the equivalent area of wetland (Gregory, MacGregor, and Lichtenstein 1992).

- *Numeric expression effects*, which find that information about an environmental good or a heritage site is over- or undervalued depending on the type of numeric expression used to characterize a good’s status. Presenting information in percentages (e.g., 80 percent of the local population agree that the site should be saved) instead of on a frequency scale (8 in 10 people agree that the site should be saved) leads people to undervalue that information. That is, different representations of the same probabilistic information lead to very different valuations. This is true with both expert and nonexpert populations (Slovic, Monahan, and MacGregor 2000).

- *Cognitive fogging*: The presentation of information pertinent to a decision can impose mental fatigue and thus fog the participant’s ability to juggle cognitively the many pieces of some decisions. (It is generally agreed that people can juggle three or four dimensions of a problem at one time.)

## The Weak Values-Action Link

Further problems stem from what is generally referred to as the weak values-action link. Historically, social scientists have assumed that studying held values is essential because they offer a reasonable indication of expected future behavior. Agreement with a value statement in a survey context should mean that actions that fulfill that value will be supported. Consider, for instance, Inglehart's evidence for an emerging postmaterialist value orientation (Inglehart 1995). Adherents of this orientation purport a willingness to forgo further material wealth (assuming basic needs are met) when attaining such wealth threatens the environment. When a respondent declares a postmaterialist value orientation by agreeing with the survey statement "I'm willing to accept a lower standard of living to ensure a healthy environment," one is led to expect commensurate support for actions that fulfill that position. Thus, postmaterialists might be expected to agree with a reduction in timber jobs or an increase in local tax revenues, to ensure forest health. Such expectations are, however, not substantiated by most sur-

vey results. This finding, in turn, has several implications for studies of environmental values.

Evidence from a recent study of eastern Canadians' environmental values in a forest management context offers a case in point (Satterfield and Gregory 1998). In that study, Ontario's population (a largely urban "general public") was randomly sampled, as were residents of rural timber-dependent communities and residents of timber-dependent households within those communities. Despite the demographic and likely ideological differences across these urban-rural groups, surprisingly universal support for "green" values emerged. In only one instance do two of these three groups differ as to their stated value orientations by more than a few percentage points. More typically, support across all groups for several proenvironment value positions is very uniform, a pattern that is maintained when moving from the resounding support for species egalitarianism to more cautious endorsements of the spiritual qualities in nature, or of postmaterialism generally. The results are depicted in Figure 1.

Figure 1 Environmental values: General public, timber-dependent communities, and timber-dependent households (percent "agree" and "strongly agree" responses). \*  $p < .01$ . (Source: From "Reconciling Environmental Values and Pragmatic Choices," by T. Satterfield and R. Gregory, 1998, *Society and Natural Resources* 11, p. 632. Copyright 1998 by Taylor & Francis. Reprinted with permission.)

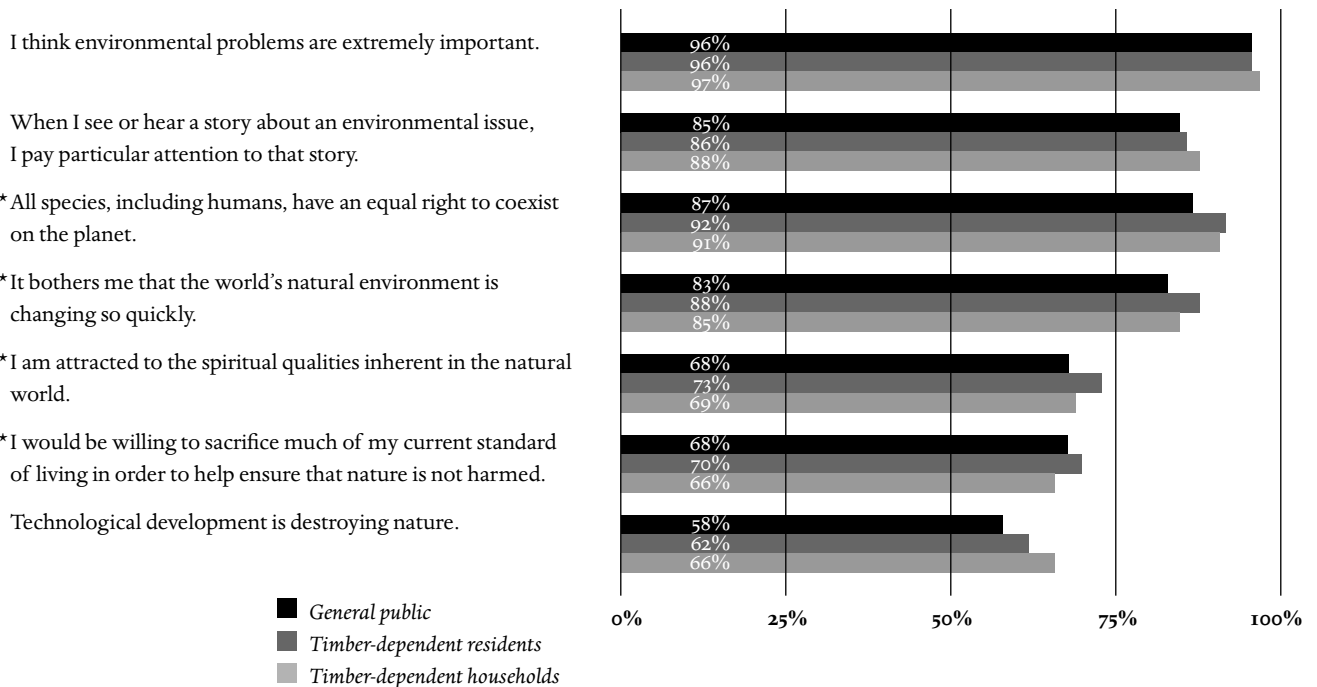
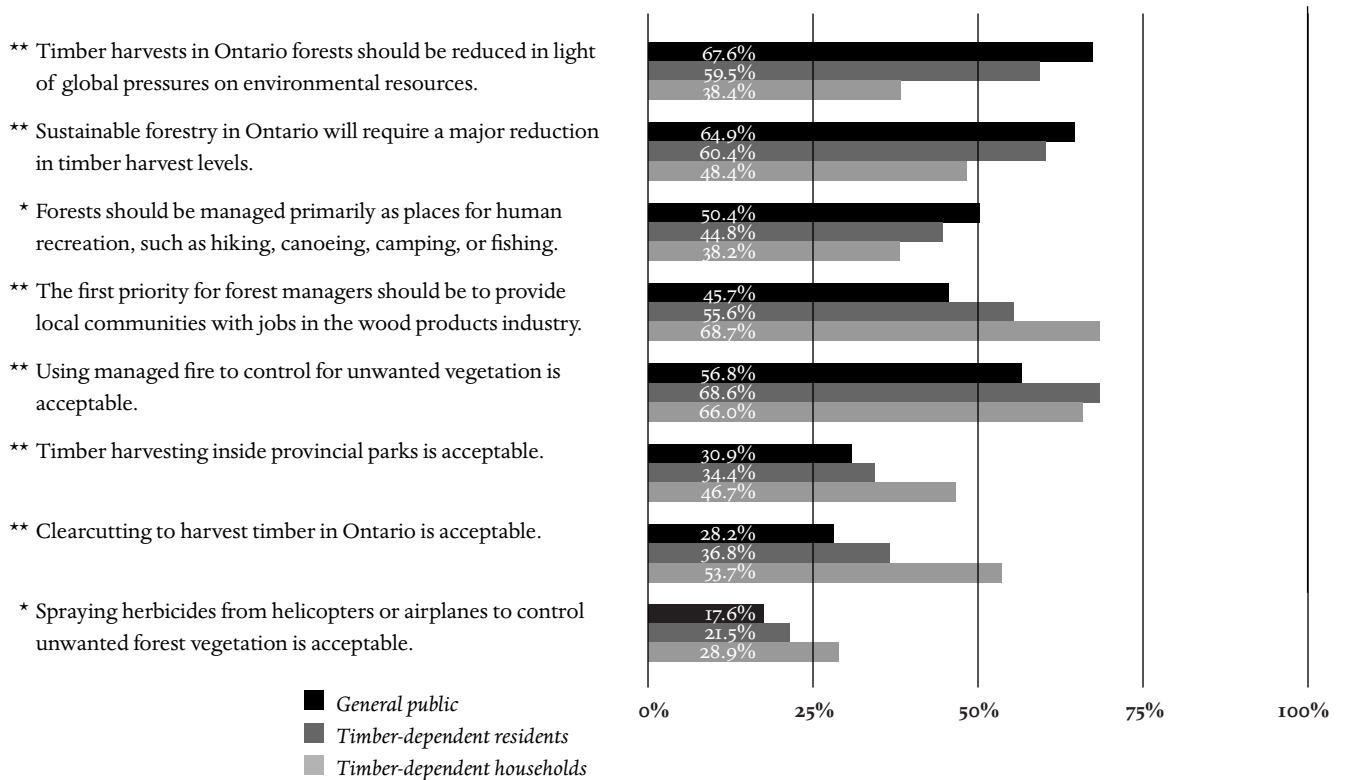



Figure 2 Management goals and actions (percent “agree” and “strongly agree” or percent “acceptable” and “very acceptable” responses). \* $p < .01$ ; \*\* $p < .001$ . (Source: From “Reconciling Environmental Values and Pragmatic Choices,” by T. Satterfield and R. Gregory, 1998, *Society and Natural Resources* 11, p. 634. Copyright 1998 by Taylor & Francis. Reprinted with permission.)



These results are in concordance with the work of Kellert and of Dunlap and Van Liere, to the extent that environmental values, once assumed to be central to the differentiation of social groups generally opposed to one another, are more widely held than one might think (Kellert 1996; Dunlap and Van Liere 1978). However, a similarly consistent relationship between expressed preferences for management goals and actions cannot be found. These findings are represented in Figure 2. At the level of action, pronounced between-group differences emerged in the Ontario study in response to the acceptability of clear-cutting (a difference of 25.5%), harvesting in provincial parks (15.8%), the reduction of timber harvesting to promote global environmental health (25.5%) or sustainable forestry (16.5%), and the importance of timber industry employment (23.0%).

The implications for assumptions about value studies (and the ability to sustain confidence in common methodologies) are twofold. First, resounding support for environmental values, even strongly biocentric ones endorsing species egalitarianism, is a relatively poor indicator of support for management goals or practices. Second, the problem is not likely to be solved by designing better value statements for survey purposes because the problem arises from the tendency to confuse expressions of values that refer to an individual’s fundamental beliefs (held values) with operational expressions of those values in terms of context-specific objectives or the means by which desired values are realized (Kraus 1995; Ladd and Bowman 1995).

## Language and Meaning

Also central to criticisms of value scholarship is the question What languages are most appropriate to the elicitation of value? The concern is that the linguistic style that accompanies cost-benefit analyses and dollar measures inscribes particular forms of discourse into the elicitation process itself. That is, the language (in most cases, an economic one) used to measure or discuss stakeholder “values” determines the values that are “allowed” to surface in the research context. An economic frame insinuates a market preoccupation and, more broadly, a rationalizing discourse that may unintentionally exclude moral or political imperatives (in favor of bureaucratic and techno-scientific ones), despite the fact that key stakeholders often defend their claims in the most profoundly moral terms (Brosius 1999, 36–40). Lockwood similarly notes that many elicitation instruments fail to “give participants any opportunity to explore different ways of expressing their values.” In the absence of alternatives, participants “must offer a response that is against their preferred mode of value expression” (Lockwood 1999, 394).

## The Purchase of Moral Satisfaction

Evidence for the argument that the format and language of valuation methods limit respondents’ ability to articulate the moral dimensions of value properly is particularly compelling in the context of WTP studies. Such studies frequently produce what are known as “protest zeros,” as well as unusually high WTP amounts. These are instances where study respondents resist the prevailing format by entering a zero or by offering an unrealistically high value, in response to questions about the worth of an environmental good. Quite often these entries are accompanied by margin comments reflecting the respondent’s discontent with being asked to think of the environmental good in question in monetary terms.

Kahneman and colleagues explain this protest as rooted in a misunderstanding, by economists, of the evaluator’s intent (Kahneman and Knetsch 1992; Ritov and Kahneman 1997). Economists supportive of WTP methods assume that value is easily and accurately assigned by the respondent, who, as a rational agent-consumer, uses that dollar assignment to express his or her preference order for environmental goods or states. A higher dollar value, it is assumed, will (a) be assigned to states (e.g., clean water) preferred over and above other states, and (b) reflect the true amount that people are willing to pay, in

the same sense that if you prefer car A over car B, you’re likely willing to pay a fixed amount more for car A. How much more depends on your income and on your subjective degree of appreciation for car A.

But if, as the above work on framing effects in judgment and decision making suggests, valuations are often inexact or labile—and thus they can change as judgment conditions are altered—something other than a conventional market transaction must be taking place in the mind of the respondent. Support for this speculation was derived, initially, from a set of results known alternately as the scoping problem, the embedding effect, or the part-whole problem, which finds that when evaluating non-market goods, participants are insensitive to quantity. That is, WTP amounts do not change significantly when the value of saving one lake, versus all of the lakes in a region, is rated. Moreover, average WTP correlates highly with support for the good in question and ratings of satisfaction derived from making a contribution. It is, therefore, probable that rather than treating the transaction as the purchase of a good, respondents are in fact purchasing something akin to the moral satisfaction achieved from contributing to a cause. Theirs are symbolic actions that express the intensity of their feelings about a good and the moral importance attributed to that good.

## Resistant Participants and Taboo Trade-offs

A second body of evidence supporting the idea that respondents are dissatisfied with attempts to over-rationalize their expressions of value by treating valuation as a market transaction stems from work on “protected values” (Baron and Spranca 1997) and taboo trade-offs (Fiske and Tetlock 1997). Valuation exercises can be an uncomfortable experience for many participants because the exercises force them, whether implicitly or explicitly, to make trade-offs that may give rise to moral and ethical dilemmas that are fundamentally difficult to resolve. A growing body of evidence suggests that many people are deeply offended by or have a profound psychological aversion to trade-offs because they view a subset of trade-offs as violating norms they seek to protect or regard as sacred. For instance, a person who holds as essential the protection of an endangered species might reject outright a WTA or WTP formula that trades dollars for that species’s survival. Such trade-offs are experienced as abhorrent because the task reflects back to the participant a self-portrait as morally compromised. Willingness

to make trades becomes tantamount to acknowledging that one's defense of bald eagles can be bought off or that one is willing to discredit the sanctity of life by deciding how many human lives should be saved.

In practice, this lack of a willingness to address trade-offs and incorporate them into policy decisions has a number of results.

- *Absolutism*. Trade-off efforts often break down because the posed options trigger respondents into believing that they must sacrifice a deeply held principle in order to participate in any negotiation or decision process.

- *Quantitative insensitivity*. The hallmark of protected values is the belief that scale does not matter, that an act or management choice is taboo, regardless of scope or occurrence. Participants may believe that destroying one species through a single act is as bad as destroying a hundred through a single act, and therefore, they refuse to participate in a discussion about possible trade-offs (Baron and Spranca 1997).

- *Denial*. Study participants often refuse to believe that one must face an unpleasant trade-off, and thus they deny the trade-off's necessity or suspend decision making until a more palatable option can be found.

- *The slippery slope dilemma*. Finally, trade-off resistance can also be equated with the belief that any move in a particular direction, no matter how minor, will lead to or is symbolic of devastating future outcomes. This is akin to legal decisions that are established on the basis of minor infractions but which are ultimately contentious because they hint at the undermining of such inalienable rights as free speech.

The argument that people are not assigning value but are, rather, avoiding trade-offs or purchasing moral satisfaction because they are denied proper opportunity to express the ethical dimensions of the problem suggests strongly that value scholars may have overrationalized their practices and that, in so doing, they have failed to address properly the moral qualities that give shape to much of what we value. Nor is the problem unique to economic protocols. The same might be said of some survey instruments that operate on the premise that we can ask respondents direct questions and receive direct answers about values. Both survey and WTP elicitation contexts may be so robotic or flat (affectively speaking) that they strip the valuation context of meaning. Functionally, they expunge the valuation context of the very language and style that many people use to discuss values—that is, the conversational talk and sometimes pas-

sionate argument that are part of everyday reflections on beliefs and values.

One needs to consider the possibility that some values cannot or should not be rationalized (at least not initially); to do so is to risk marginalizing value positions based on affective investment or moral conviction. Rationalizing processes may compel respondents to avoid expressions of value that come across, to put it bluntly, as flaky, despite the possible importance of ethical propositions about the rights of nature and spiritual investments in natural areas. It may be that many study participants are not especially good at giving voice to values that are ethically charged, deeply held, privately defended, or not available to consciousness at a moment's notice—or perhaps participants are not even given the chance to do so. Tangible, rational values, such as those that specify nature as biologically and economically beneficial, are readily defined in most elicitation contexts. In contrast, less-tangible expressions of value, such as the proposition that rights should be extended to nature or that wild nature is enchanting or sacred to some people, are relegated to quiet corners.

---

### **Balancing Numbness and Sensitivity**

This is a sobering list of problems, and it is reasonable to assume that no single valuation tool will likely emerge to solve all of the difficulties posed. Instead, it is necessary to recognize that there is only, at best, a certain art and science to balancing the powerful affective, aesthetic, ethical, and spiritual values about nature held by many stakeholders and the demands of complex, technical, on-the-ground considerations of what, where, when, and how to proceed when a balance between human and natural welfare is sought. The point, therefore, is to transparently seek balance between numbness and sensitivity. Numbness may set in when study participants are deprived of opportunities to think through the complexity of a value-driven decision or are estranged by the style, language, process, or value-exclusivity of an approach. Sensitivity might alternately refer to participants who are oversensitive to single features of a value problem. Perhaps they hold fast to (or are highly sensitive to) single-item priorities that they seek to protect against all others, and thus they are unwilling to make trade-offs or consider different management options.

In response to much of this, a new breed of value studies is emerging that works to (a) provide contexts that enhance participants' ability to articulate more elusive or impassioned expressions of value, (b) address the cognitive complexities inherent in most decisions about how best to "manage" nature, (c) create better links between the value stated and the action endorsed, (d) place on equal footing value dimensions that are qualitatively disparate—from the deeply moral to the fiscally practical, and (e) examine the conditions under which careful deliberation of problems is enhanced. Moreover, the entire field is moving, it seems, from more abstract studies and categorizations of value to the implications of such values for concrete, context-specific decisions about different planning and conservation options. An expansive mood is afoot wherein experimentation is encouraged and convention is sometimes, though not always, subverted. What follows is a train of research thought that reflects these newer breeds of research—in particular, efforts with which I am involved or most familiar.

### **Value Articulacy**

Consider first the problem of value articulacy—to wit, the problem that some values cannot be expressed as numbers or declarative statements but are, instead, embedded in the contextually, emotively, and morally rich stories and conversations through which we define ourselves and our actions in relation to natural systems. With this in mind, one set of studies (Satterfield 2001) speculated that more inclusive portraits of value could be found in value-rich narratives if only one could elicit such narratives from lay stakeholders in a defensible manner. These studies assumed that morally resonant, image-based, and narrative-style elicitation would help respondents articulate a broader range of noncost and nonutilitarian environmental values. Three elicitation tools were developed toward this end. One of these mimicked a projective test, the Thematic Apperception Test (TAT). Respondents were asked to tell a story about what the (unidentifiable) person in a photograph of an old-growth grove or a clear-cut was thinking. A second tool sought open-ended reactions, or in some cases rebuttals, to several affectively charged "pro" and "anti" narratives about logging activities. This task exploited the connection in the respondent's mind between emotional investment in a point of view and expressions of value (Lutz 1988; Stocker and Hegeman 1996). A third device told the story of a policy dilemma about a rare species of pine on the brink of extinction and

the desire to harvest that species because it provided an essential ingredient known to send into remission 50 percent of all cases of lymphoma and leukemia. Respondents were asked to tell us how they would resolve the conflict and to explain their actions on the basis of their sense of a "just," "fair," or "moral" world.

Several hundred pages of written responses were produced. Identifying the different invoked value expressions was understandably difficult. Moreover, the research sought better representation of ethical values, which necessitated a coding scheme that spelled out such value dimensions. Rolston's book *Conserving Natural Values* was used as a basis for developing that coding scheme (Rolston 1994). Each chapter was culled for discrete types of value. Over thirty-five categories of value were generated, though some categories were eliminated due to overlap and due to nonmention by respondents. In the end, twenty-five categories of value remained pertinent. These are defined in Table 4.

The rich, lengthy, and value-dense passages that characterized responses to these three tasks lends credence to the claim that under "naturalistic" conditions (i.e., conditions that mimic ordinary talk and ardor), participants have a great deal to say about values. Consider the following passage taken from a participant's response to a thematic apperception task using an old-growth photograph. It is not an exceptional passage, and like many, it is unabashedly romantic (a discursive style ill suited to conventional valuation exercises). Nonetheless, it manages to convey meaning as defined by the forest's capacity to invoke the ephemerality of human life, to suggest that forests represent something larger and more enduring than the human self. "She hiked farther, finding herself beneath a canopy of old growth shade. She was amazed by the immense size of the trees, which due to old age and climate were covered in moss. Staring out at the tree, she thought to herself, 'It's so old.' She thought further about her age in relation to the trees. It occurred to her that her life was a very small part of the life of the earth."

Briefly stated, 416 expressions of value emerged across the twenty-five different value categories. Figure 3 depicts the ordering of value categories according to their frequency of mention across all elicitation tasks. The top six of these categories (ecological sustainability, principles of equity and the rights of nature, philosophical or spiritual values, recreational values, aesthetic value, and life support value) encompass the large majority (65.1%) of all responses. Less-common, though intriguing, value references include:

**Table 4** *Value Definitions.* (Source: Rolston's *Conserving Natural Values* (1994) was the basis for this coding scheme. Each chapter was culled for discrete types of value. The definitions in column two either quote or paraphrase Rolston (1994); column three gives page references to Rolston's text where applicable. The author takes full responsibility for these definitions; they are summations of her reading of Rolston and should be understood as such. Adapted from "In Search of Value Literacy: Suggestions for the Elicitation of Environmental Values," by T. Satterfield, 2001, *Environmental Values* 10, p. 341. Copyright 2001 by The White Horse Press, Cambridge, U.K. Adapted with permission.)

<b>Value Category</b>	<b>Definition</b>	<b>Pages</b>
Ecological sustainability	Valuing development that does not compromise ecosystem integrity	85
Rights/ equity	Deliberations on the rights of nature, including: (a) basic idea that nature has rights, (b) idea of balance between humans and natural rights, (c) idea that rights of nature take priority over humans, (d) idea that human rights take priority over nature	106–13
Recreational	Nature as provisioner of a physical challenge (e.g., mountaineering), as a show to be watched (e.g., bird-watching), as a place to build skills (e.g., scouting organizations)	135
Philosophical/spiritual/religious	Nature as a philosophical and religious resource, as inspiration for religious/philosophical/spiritual thought and experience	140–41
Aesthetic	Beauty in life and landscape, admiring a rainbow/snow-capped mountain, etc.	136
Life support	Earth as a biological habitat/home. Biosphere as a source of climate, water cycles, photosynthesis, etc.	7
Historical/evolutionary	Historical value of nature and landscapes as a record of past processes (geological formation of the earth) and as an evolving system	76
Future generations	Recognition of the rights of future generations to a healthy environment	19–21
Population sustainability	Concern about nature as it meets human needs; concern for the equitable division of products of nature among Earth's citizens	145–50
Economic	Commodity value of extracted natural resources	134
Employment	Valuing resource-based jobs	—
Biodiversity	Valuing the preservation of biodiversity expressed as variety of species (number of species present) and rarity of species	34–37
Place identification	Nationally recognized places—e.g., "the prairies"	8–9
Pharmacy	Valuing resources in nature that can cure human illness or have the potential to cure human illness	—
Wilderness	Valuing the existence of wilderness or wild places	186–192
Intrinsic	Value inherent in nature in and of itself, not because it serves some human, biological, or ecological need	167
Community	Recognition of humans as members of the biotic community and/or valuing the idea of a biotic community	81
Complexity	Valuing the complexity and intricacy of material systems	181–84
Scientific/intellectual/creative	Valuing nature as a basis for creative or intellectual thought	135, 195
Recovery	Valuing the ability of an ecosystem to heal itself, to recover from natural or anthropogenic devastation	88–93
Existence	Valuing the simple possibility that a natural place is out there and in good shape, though one may never see it	—
Cultural sustainability	Valuing the relationship between cultural and biological sustainability	1–6
Cultural symbolization	Wildlife as cultural symbols—e.g., bald eagle for the U.S.; the maple leaf for Canada	137
Charisma	Valuing nature for its charm and character; emphasis on charismatic megafauna	61
Oppositional forces	Valuing the struggle between destructive and life-giving forces of nature	139

Figure 3 Most- to least-commonly-invoked categories of value across all seven elicitation opportunities (total number of mentions of value categories). \*denotes categories in which at least half of total responses were generated by conflict scenario; \*\* denotes categories in which at least half of total responses were generated by old growth TAT; † denotes categories in which value was invoked in at least six or seven possible elicitation conditions. (Source: From “In Search of Value Literacy: Suggestions for the Elicitation of Environmental Values,” by T. Satterfield, 2001, *Environmental Values* 10, p. 343. Copyright 2001 by The White Horse Press, Cambridge, U.K. Reprinted with permission.)

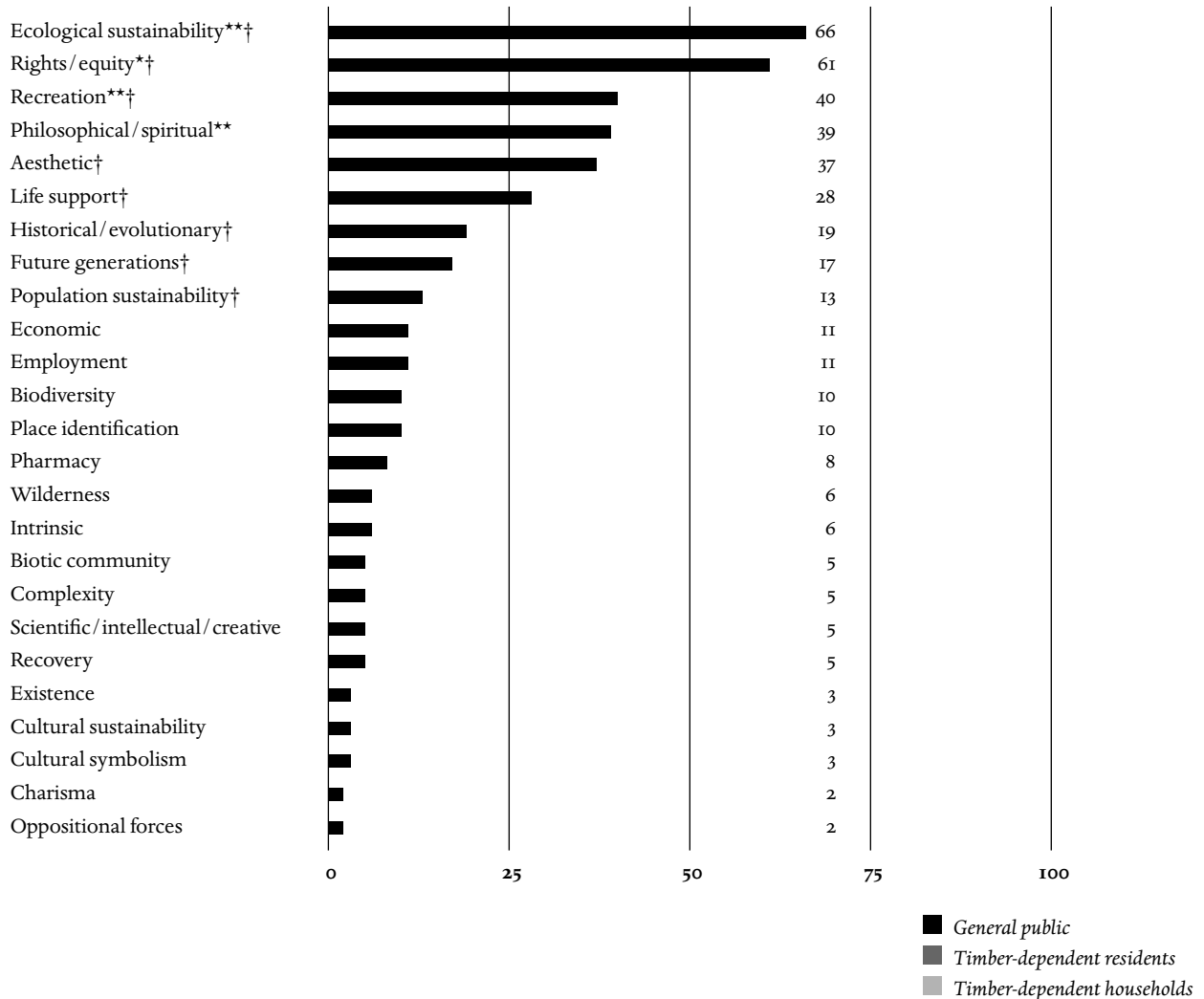

- positive valuations of the historical and temporal evolution of biotic life (“This tree has been around for thousands of years.” Or “Standing and looking at the land laid out before me, I feel a great sense of loss for our world. It takes such a long time for a forest to grow.”)
- recovery value (“I appreciate the recuperative powers of nature.”)
- complexity value, that is, valuing a physical place for the intricate processes and systems that are within it (“She takes notice of the symbiotic relationships she sees around her, the moss and the tree body . . . an example of the ideal interactions that occur between organisms.”)
- intellectual and scientific value—rather positive

valuations of natural phenomena as the basis (via reflection and study) for human intelligence and creativity.

Other responses were notable for their interweaving of values—to wit, for the contributions of biotic health to psychological and cultural health, or for the sheer force of imagination apparent in some responses: “Massive barked, moss-covered, ancient soldiers that protected the gates to the true muse of nature, loves poetry.”

Several explanations may be tentatively proposed for the elicitation tasks’ ability to encourage discussion of a broad variety of noncost and nonutilitarian values. A first plausible explanation is that allowing for ordinary, storied talk of values during elicitation created a comfort

zone or imaginative cognitive environment, which in turn encouraged expansive thinking about value. A second plausible explanation noted above is that values are affiliated with symbols. Natural phenomena, concretely imagined through image (photographic) stimuli, suggest (“symbolize”) different meanings to different people; values are stored in symbols to the extent that such symbols sum up or resonate personally and socially important qualities (Geertz 1973, 127). A third possibility is that while some dimensions of value focus on material worth or contributions to systemic health, other dimensions are closely related to states or to what is sometimes called experience—states of mind, bodily states, and other sensory events. This distinction is akin to the distinction in behavioral decision theory between decision utility (the utility derived from assigned weights or dollar estimates at the time of the decision) and experienced utility (defined by the quality and intensity of the hedonic experience associated with the outcome of the decision) (Kahneman and Snell 1990, 187–88). One might value a forest for its timber, its board-feet productivity, but one might also value a forest because, as many participants noted, a forest provides the (quasi-spiritual) experience of “awe” or, as other participants noted, offers the chance for an intersensory exchange (“the experience of hearing the sounds of trees in the wind”) between the biophysical world and the human ego or self. Narratives often focus on personal experience and may, therefore, be particularly suited to the elicitation of value states or experienced utility.

While the above research outcomes were descriptively worthy, the hope was that the narrative elicitations would provide a basis for developing better value-focused questionnaire items—expressions that could be used in survey contexts to improve researchers’ capacity to predict the relationship between the values held by a respondent and the endorsement of a related action or policy choice. But breaking the narrative elicitations down into their value-component parts for the purpose of survey work seemed to defeat the original purpose. That is, the narrative wholes seemed greater than the sum of their parts, and so using these individual value statements (extracted from the elicited narratives) did not strengthen the relationship between preferred actions and values rated as very important in a survey.

The response to this dilemma unfolded in two stages. In the first stage, the belief that the narrative whole was greater than the sum of its value-component parts was tested by comparing the impact of four forestry-related value narratives (none longer than one page) and

four parallel sets of value statements on support for land-management practices. The value positions articulated in the narratives were exactly the same in number, order, and principle as the value positions articulated by the survey-like statements. Only the style of delivery differed—that is, values as narratives versus values as statements. The results were surprising: the impact of the forest-management narratives on the policy choices was very different from the impact of the statements, despite the substantially identical content. Support for the policy options between the two conditions (narrative and statement) differed by as much as forty percentage points. The pattern of impact was not always consistent, just vastly different. Thus, it was concluded that task participants listened to and responded differently to (i.e., did something cognitively different with) narratives as compared to statements (Satterfield 1999).

Shanahan and colleagues conducted a similar experiment (Shanahan, Pelstring, and McComas 1999). They, too, developed surveys using “ordinary talk” or narrative passages instead of conventional belief statements. Specifically, they compared survey items drawn from Riley Dunlap’s above-mentioned new environmental paradigm (NEP) to respondents’ evaluations of story outcomes (Dunlap and Van Liere 1978). Shanahan and colleagues affirmed an abiding respect for surveys, but they also found that narratives are a “distinct communication context that may provoke different thoughts and feelings than simple belief statements” and that “narrative measures can tap into different constructs [as compared to] typical attitude measurements” (Shanahan, Pelstring, and McComas 1999, 412, 416).

In the second stage, it was recognized that the above, open-ended elicitation results were limited by their descriptive but not analytic outputs. As such, they do not lend themselves easily to the statistical rigor and representativeness of surveys. Value literacy may refer to participant capacity to verbalize multiple dimensions of value, but literacy should also include some understanding of what verbal descriptions mean at the level of specific policy options and how widespread or representative those policy judgments are. It was therefore surmised that when surveys are necessary, value elicitors might instead use “pathways” of questions (thematically linked sets of questions). Pathway work is rooted in the constructed preference paradigm (described below) and can be used to create something akin to a step-by-step narrative<sup>7</sup> that more closely follows the reasoning that connects values with actions (Satterfield and Gregory 1998).

## Constructed Preferences and Pathway Surveys

Constructed preference approaches are born of the problems and criticisms cited above, which note that framing effects, trade-off difficulties, cognitive fogging, and decision complexity pose a challenge for analysts and valuation researchers working in real-case contexts. The researcher is caught between the need for informed choice and the knowledge that relatively subtle cues can influence judgments. These approaches have therefore redefined decision making and valuation practices as actively constructive processes that must avoid unrealistic cognitive demands by offering the decision maker conscientious supplementary and contextual help in the teasing out of good-quality judgment information. This in turn helps move concerns about framing effects from the passive stance of avoiding judgment errors to the active construction of an improved and appropriately defensible decision context (Gregory, Lichtenstein, and Slovic 1993; Payne, Bettman, and Johnson 1992; Payne, Bettman, and Schkade 1999; Slovic 1995).

In practice, constructed preferences can be accomplished by the use of a decision pathway survey (Gregory et al. 1997; Satterfield and Gregory 1998). By way of example, let's return to the findings noted above, where residents in disparate Ontario communities (from the very urban to the very rural and timber dependent) appeared to similarly endorse several key environmental values and yet disagreed strongly about specific forest management practices. Monitoring public opinions and values by eliciting agreement or disagreement with simple statements may disembodiment values and thus mask the situational richness and overall narrative train of thought that takes a respondent from point A (a stated value or objective) to point B (a considered management action). Expressions of environmental values may be of merit in and of themselves, but if values research is used to inform policy, then the products of this research must be shown to apply to specific applications or contexts. Pathway surveys work to strengthen this link, conveying more clearly the reasoning behind respondents' decisions.

Following the insights of constructed preference theories, the pathway approach attempts to assist participants in completing the following three fundamental decision steps:

- *Framing the decision*, in terms of recognizing the key contextual elements of the decision situation. In a forest policy context, the decision frame might involve speci-

fying exactly what is being proposed, whether the action is novel or routine, whether it threatens wildlife habitat, and whether it benefits some communities and not others.

- *Defining key objectives*, which requires carefully noting what concerns arise in the context of the decision.
- *Making trade-offs among these objectives*, which is difficult because it requires an explicit recognition of the conflict across desired objectives, as well as knowledge of the facts of the situation. Thinking about trade-offs is complicated by the nature of the objectives in conflict. As noted above, some values hold special meaning and thus are resistant to trade-offs. Or it might be easy to measure the effects of some value priorities (e.g., the number of jobs provided) but not of others—say, the importance of a less-discrete effect, such as loss of aesthetic or cultural value through the physical disruption of a site.

In such pathway surveys, all participants are asked an initial question to establish broad distinctions or paths of opinion (e.g., "Do you prefer 'a' or 'b'?"). They are then asked a set of questions meant to tease out the reasons behind their initial response, including an examination of the objectives behind their preference ("Is that because you want 'x,' 'y,' or 'z'?") and any concerns (risks) that may explain their reasoning ("In thinking about 'a,' do you worry about \_\_\_ or \_\_\_?").

The following decision pathway questionnaire began by presenting a scenario detailing plans to log a remote tract of land containing sixty- to eighty-year-old trees and thereafter to replant that land with a mixed combination of tree species. All respondents were initially asked about the desirability of "controlling nature" by managing competing vegetation among newly planted trees. Each response was followed by a series of related questions about respondents' reasoning processes; these questions varied according to the person's previous responses, thus forming a decision pathway. This approach allows the researcher to challenge basic value judgments about controlling nature with more complex questions about forest management and about why controlling for unwanted vegetation is seen as undesirable or not. It determined what kind of vegetation management is acceptable and under what circumstances, and it asked about the risks thought to accompany certain management practices (e.g., the spraying of herbicides). Moreover, these constellations of linked questions helped unpack generally stated principles about controlling nature and the appeal of related actions, such that information about trust, risks, and rationalizations associated with different management alternatives was revealed.



Figure 4 Decision-pathways map—selected pathways. Questions 6 and 17 (marked by \*) were each asked twice, on two different pathways. (Source: From *Vegetation Management in Ontario's Forests: Survey Research of Public and Professional Perspectives*, by S. Johnson, T. Satterfield, J. Flynn, R. Gregory, C. K. Mertz, P. Slovic, and R. Wagner [Sault Ste. Marie, Ontario, Canada: Ministry of Natural Resources, 1995], p. 49. Copyright 1995 by Queen's Printer for Ontario. Reprinted with permission.)

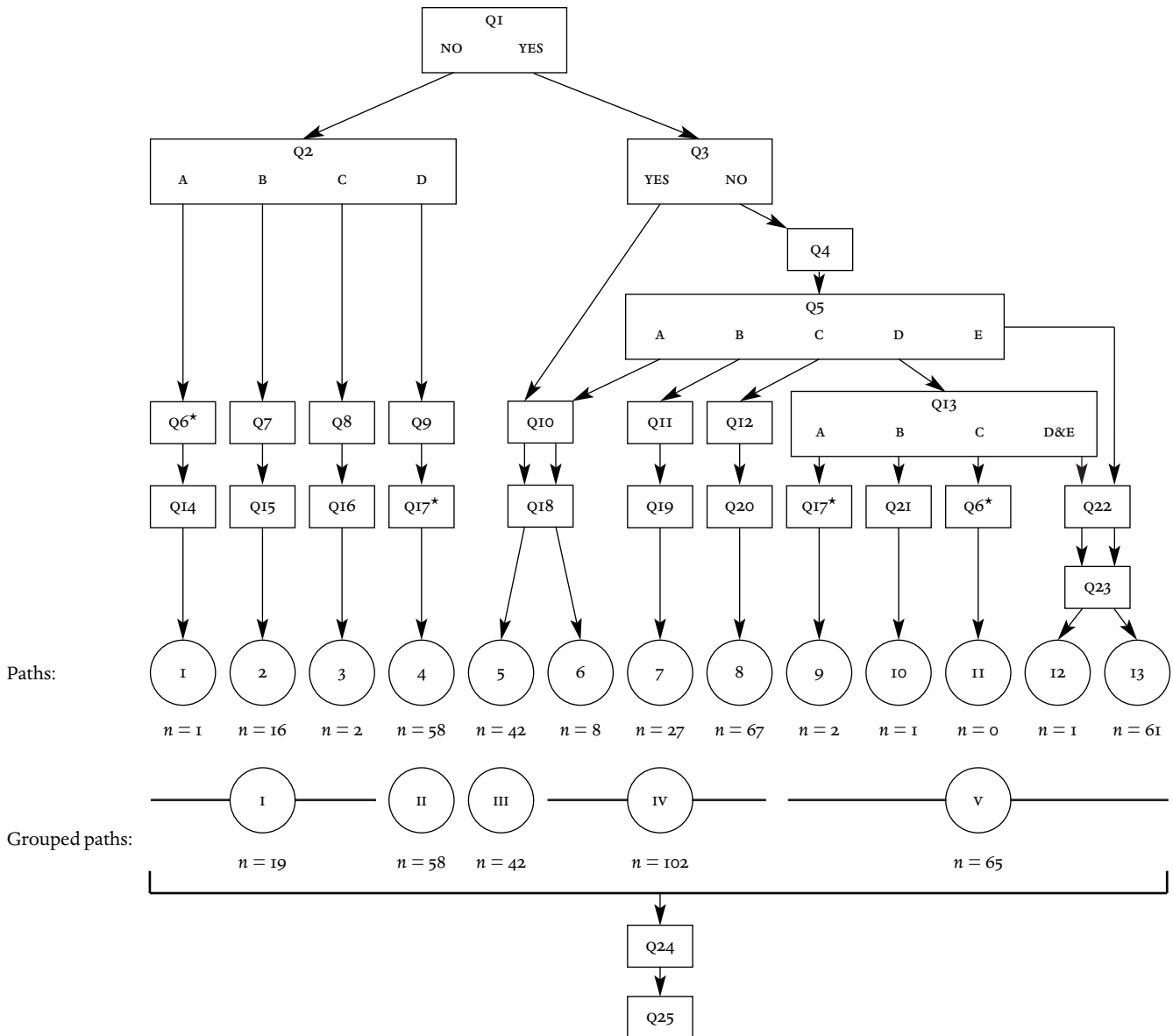

Thirteen potential decision pathways were available to survey respondents. Figure 4 illustrates this; five paths (path numbers 4, 5, 7, 8, and 13) attracted most respondents, while others attracted only a few participants, or none at all.<sup>8</sup>

Ultimately, pathway studies take standard survey methods to a nuanced (i.e., less abstract) level by helping respondents think through conflicts or vagueness in their answers and stated value positions. The step is an important one because, as found above, participants who uniformly support a biocentric vision of nature cannot be

assumed to demonstrate a similarly uniform endorsement of management directives. Simple, even radical, expressions of environmental values may have so permeated our collective imagination that it is easy to invoke their theoretical importance when asked for agreement with a survey item. But when such invocations fail to predict related actions, it becomes essential to move beyond the idea that the richness of environmental values can be understood through responses to discrete “sound-bite” sentences in a survey.

## **Narrative Valuation as a Constructed Preference**

The decision pathway approach offers a defensible approach for addressing the problems of framing effects and of the weak link between values and actions, as well as the cognitive difficulties posed by complex decisions. Its narrative-like, step-by-step method is also promising. However, the full benefit of narrative expressions is not necessarily embodied in this approach, because the emphasis in pathway studies still rests heavily on “rationalizing” one’s thinking by systematically breaking decision problems down into their component parts and subjecting those parts to examination.

Given this, it is worth comparing the benefits of presenting a decision problem using a “just-the-facts” rationalizing style typical of some constructed preference exercises as well as of many cost-benefit studies, to the benefits of using a narrative style characterized by the experiential language of storytelling, including the retelling of a believable sequence of events by use of first-person narration and image-based description.

Reference to the narrative literature points to the hypothesis that narrative decision frames would better serve the need to clarify background information, inculcate expansiveness of thought, and engage participants via use of a meaningful and relevant language. Embedding multiple types of value (from the ethical to the technical) within a narrative may be optimal because narratives are said to trigger dual modes of cognitive processing (a rationalistic mode and a narrative-experiential mode). Theories of dual modes of processing can be traced to Aristotle’s *Nicomachean Ethics* and are best expressed contemporarily by the work of Bruner and Epstein (Bruner 1986; Epstein 1994). Both have proposed that human cognition relies upon two modes of thought: “a paradigmatic or logico-scientific” mode and “a narrative mode that deals instead with good and believable stories.” More important, “efforts to reduce one mode to the other or to ignore one at the expense of the other inevitably fail to capture the rich diversity of thought” (Bruner 1986, 11–13).

Narrative valuation tools also seem compatible with constructive methods because narratives, by definition, are largely built around plots or event structures that can be analogously used in valuation contexts to outline the attributes of a problem (Rimmon-Kenan 1983). The attributes of a problem can be clearly stated as features of the plot but are also memorable due to their linkages to one another; the plot structure provides an overall cogni-

tive map of the problem (Kearney 1994). Further, when judgment problems are complex and ethically challenging, study participants have also been shown to impose their own narratives to help manage decisions. For example, Pennington and Hastie discovered that jurors constructed narrative-like summations of trial evidence, summations that equipped participants to process their judgments of guilt or innocence (Pennington and Hastie 1993). Ease of processing might also enhance knowledge integration, which is akin in valuation contexts to the bringing together of multiple dimensions of value in order to generate a summary judgment. A coherent and interesting story may increase comprehension of the text’s main ideas, allowing participants to answer complex questions about content and apply the information to new situations (Kearney 1994, 431). This ability is fundamental to value analysts’ concern for respondents’ capacity to work with the value attributes of a problem and link those attributes to a judgment about policy. Finally, a possible reason for the efficacy of narratives in valuation contexts is their ability to facilitate task engagement by operationalizing a language that is consistent with lay talk of values. Engagement of participants can be achieved by employing emotion to add meaning to otherwise abstract information and by concretizing information through the use of imagery and anecdote (Finucane et al. 2000; Kida and Smith 1995). Oatley similarly finds that it is through effectively engaging devices that we enter into the world of the narrative (Oatley 1994). By seeing the problem from the narrator’s point of view, we take the problem on as our own and endeavor to solve it from a less-distanced perspective than might be typical of cost-benefit or survey practices.

A study of the values underpinning decisions about reducing the productivity of hydroelectric dams to enhance salmon runs was designed to test these speculations. Two decision problems were developed; one employed a rationalist style, the other a narrative style. Both versions contained parallel information about two quantitative value dimensions (about changing salmon populations and changes in the cost of hydroelectric power) and two moral value positions (about the meaning of salmon to the community and about the spiritual importance of the dam and the river to the community).

Sample texts from the two conditions were as follows: The rationalist text opened with an introduction of the problem, which was quickly followed by a reference to the geographical setting and case: “A large number of hydroelectric dams have been built in the Pacific North-

west over the past seventy years to generate electricity. . . . The Monroe River is representative of many river systems that produce power and salmon.” This text later includes the following: “Key policy decisions involve concerns such as the timing of power production (e.g., letting more water through dams on a regular basis would decrease the amount of power produced but also increase spawning habitat and food availability for young salmon). . . . The expectation is that increased water flow will raise the number of returning salmon on the river by at least twofold (8,000 salmon instead of the current 4,000) and possibly as high as tenfold (or approximately 40,000 salmon).”

The narrative text opened with the introduction of the narrator and an evocation of place: “There is a lot of talk around here lately about salmon habitat and hydroelectric dams. I am reminded of this as I drive along the road that borders the Pacific Northwest’s Monroe River.” The text later includes the following: “My neighbor, an engineer, has taught me a thing or two about how dams and their hydroelectric technology can be managed in ways that kill fewer young salmon. She says that increasing water flow around the dams would help. Right now only about 4,000 salmon are making it back per year, but if more water is released through the dam, salmon habitat and food availability will improve, and more young salmon can survive the passage to the ocean and return years later to spawn. My neighbor also thinks that an increase in water flow could increase the salmon population by at least twofold (about 8,000 fish a year compared to the current 4,000) and by as much as tenfold, or about 40,000 returning salmon a year.”

The results of this test were compelling: After reading the background text (narrative or rationalist), respondents were asked to evaluate eight policies based on different high/low manipulations of the four value dimensions. The eight policies represented a 24 fractional replication, which made the value dimensions uncorrelated across the eight policies.

Multiple regression analysis allowed us to isolate the values that actually influenced or drove the decision (versus relying on participants’ self-reports about which values mattered). It turned out that participants in the narrative condition were highly sensitized to high/low manipulations of value attributes in the policy options. Beta weights for the narrative condition indicate that two dimensions (the cost of hydroelectric power, and salmon population) significantly predicted policy support. A third dimension (spirituality) also had some influence. Con-

versely, in the rationalist condition, respondents were insensitive to changes in value-attribute levels. Support ratings were random, in that there was little or no relationship between the four value dimensions and policy support ratings, save for some nonsignificant influence from cost (Satterfield, Slovic, and Gregory 2000).

In sum, in this initial test of the efficacy of narratives for valuation tasks, narrative valuation frames appear to improve respondents’ ability to read about a subject, consider a range of values as diverse as cost and spirituality, and then link that content to a specific policy choice. This may strike many as a controversial conclusion. The very notion that narratives have something to contribute to valuation efforts may strike many as anathema to efforts that “impose” a rationalist style so as to disabuse lay stakeholders of *errors in their thinking*. And yet valuation research has been hampered for some time now by public and expert dissatisfaction with tools that are exclusionary and ill equipped to accommodate the many diverse expressions of value (from the economic to the deeply ecological). It may be that doing something as simple as valorizing value expressions in judgment contexts by putting that information into the mouths of narrators, by understanding the impact of different affective tones, by being clear about the appropriate use of narration and quantification, or by animating tasks such that decision contexts are concrete and easily imagined by participants, changes entirely participants’ ability to evaluate and judge a technically and ethically complex problem.

### **Valuation Processes and Group Deliberation**

One final development in the field of environmental valuation is the emergence of group-based deliberation. Constructive (and narrative) processes assume that better decisions will be made as researchers are able to isolate the conditions under which people think clearly and imaginatively about their values, and do so from an informed, decision-focused context. One can think of this shift as a move toward ever-greater deliberation and forethought at the level of cognition and decision making. But deliberation is a multifaceted term, and increasingly (for students of environmental values), it has come to mean not just cognitive competency but also deliberative governance or democracy. Deliberative democracy, it is argued, should be achieved not via the “totality of the preference of individual members” (i.e., the aggregation of their preferences elicited through increasingly refined methods) but

through processes of civic engagement wherein people come together to learn, deliberate, and debate the means for achieving a common good. Representative voting is central to the first, or aggregate preference, concept of democracy; it comes closest to the economists' assumption that democracy equals the sum of individual choice or welfare (the "I want \_\_\_ and am willing to pay for it" equation). In contrast, the second, "civic engagement" concept comes closest to civic republicanism (among other traditions), wherein the citizens' ability to refine their judgments in dialogue with one another is central. "Citizens engage in deliberation not so that each can determine or refine his or her own interests, but so that together they can discover a good that is not simply a function of their individual" preferences (Sagoff 1998, 225).

Venues for citizen participation in policy decisions have long been popular—from focus groups to citizen advisory boards to citizen juries—but little of this work has been formally structured around the identification and/or assignation of value. Of late, however, and in deference to these civic traditions, the context for value elicitation is moving from that of the individual to that of the group. Some practitioners have sought a halfway point such that valuation exercises are conducted in groups where extensive debate and deliberation are encouraged. Participants have to face and consult one another in the examination of a decision problem. But conclusions still rest on data collected from participants using a voting, or individual preference, model. The construction of preferences in small group contexts has also been used; in this process, an amalgam of one aspect of deliberative democracy (group dialogue) and several aspects of improved cognition or learning via decompositional analysis is achieved (e.g., Gregory 2000).

Others are more influenced by Habermas's philosophy of communicative ethics, which addressed conceptions of competent and legitimate communication and the conditions under which latent manipulation occurs (Habermas 1979). *Latent* can mean subtle, unconscious, or unintentional actions that encourage one way of thinking about a problem (e.g., via the unexamined assumption that an economic frame is neutral or ethically inclusive) or by the practice of token participation, where citizens are encouraged to present their views only to learn that the decision had already been made. Several recent volumes evaluate actual participation processes (many of which are decision- but not value-focused) according to the Habermasian principles of "fairness" (which focuses on ideal speech conditions) and "compe-

tence" (the quality of public understandings and agreements under the knowledge conditions provided) (Renn, Webler, and Wiedemann 1995). Practitioners of the Habermasian school have not historically conversed with descendants of the attitudinal-psychology and judgment and decision making practitioners reviewed above. But one can see that "fairness" follows closely the concerns with language noted above in this section, especially latently coercive language, and that competence has something in common with valuation scholars' efforts to simplify, cognitively speaking, complex decisions.

The citizen-jury model of public participation is especially promising with regard to the identification of value; it is more structured or systematized than most other practices (e.g., advisory boards) and thus fulfills some of the features of constructed processes (Armour 1995; Crosby 1995). A jury provides a venue in which citizens might ideally observe or learn about value from lay and expert bodies (economists, ethicists, social scientists, and biologists, as well as community activists articulating multiple normative positions). The jury might, with consultation, identify the desired expert witnesses themselves. They might also select the questions posed to the "value" witnesses, given the decision problem at hand. After several days of hearings, the jury would be charged to reach and defend a decision based on the values selected as most relevant to the decision context/problem. As in a court of law, this deliberative process would take into account parameters established by relevant legal frameworks (e.g., the Endangered Species Act or the National Environmental Policy Act) and regulatory standards (e.g., clean air or water standards). In a heritage valuation context, the witnesses might be multiple stakeholders (from art conservators to local stakeholders invested in the fate of a particular heritage site or public monument); whereas the regulatory parameters could be established by professional bodies not unlike the American Institute for the Conservation of Historic or Artistic Works or by professional codes for practice and ethics.

---

## Conclusion

Sorting one's way through the environmental values literature is a nearly impossible task. Articles in the published literature that include "environmental values" as keywords number in the thousands. Nonetheless, a few dominant trends are discernible. First, economic and especially preference-centric/WTP definitions of environmental val-

ues dominate the field. Though WTP methods are not the express focus of this paper, it is virtually impossible to discuss or understand the environmental values literature without some reference to WTP, because almost all other work is defined as against (or capable of improving upon) this dominant method.

Second, much of the literature can be distinguished as either axiomatic (primarily by ethicists or ecologists) or relativistic (primarily by economists, psychologists, sociologists, and anthropologists). Axiomatic practitioners do not necessarily identify themselves as such, but their work is ultimately oriented to “right” or “best” practices, however defined. Rolston’s work on “natural value” parallels most closely debates in heritage conservation about the primacy of aesthetic value (versus, say, historical or deliberate commemorative value) (Rolston 1994). But neither Rolston nor any of his contemporaries has offered an explicit schema for enhancing one’s experience or enhancing appreciation of the natural, economic, or spiritual qualities of nature. There is no equivalent in the environmental values field of Kenneth Clark’s guidelines for appreciation. This lack is due both to the newness of the field and to the timidity produced by the predominance of relativistic approaches to environmental valuation.

This brings me to my third point: Generally speaking, relativistic approaches dominate, but the extent to which practices can be fully defended as “unbiased” is compromised at best. That is, the undeniable focus on human attitudes and preferences—what people want or believe—is compromised by the fact that environmental values (particularly in the form of dollar metrics) are not clearly defined in the minds of respondents and as such are vulnerable to manipulation. Information processing errors and/or cognitive errors produced by the use of heuristics to simplify complex or unfamiliar questions are notably common. Valuation practitioners are thus suspended between the desire to be objective and the need to (a) provide information necessary for a more informed examination of value, and (b) ensure that the task is cognitively doable.

Fourth, this conundrum has inspired an ongoing period of innovation. Many now acknowledge that if the method of elicitation affects outcome, it is better to proceed with a framework that clearly exposes the researcher’s methodological rationale and, equally, renders visible the context and thinking (on the respondents’ part) that lead to the value elicited. Constructed preferences and narrative valuation practices are generally

aimed at this goal. Valuation problems are simplified or broken down into their component parts such that participants can examine the multifaceted nature of their decision. When this is done, value elicitation processes become decision-focused exercises wherein the link between a value held, a value assigned, and the support or basis for a final decision or policy is clarified.

Fifth, the rebellion against cost-centric approaches is, in part, a rebellion against the overly rationalist language of WTP and cost-benefit analysis generally. The concern is that such discursive frames silence or render invisible expressions of moral conviction, enchantment, awe, or the kind of spiritual reverie that underpins the many reasons we value nature. Group deliberation processes may come to address this problem. This is true in part because the Habermasian tradition of communicative ethics is attentive not to good cognition per se but to the democratic use of language in participatory venues.

Ultimately, all valuation exercises must clarify and defend whether they mean to be axiomatic or relativistic, whether they mean to valorize those qualities that are underrepresented or silenced, whether they mean to identify categories of value meaningful to either expert or lay populations (versus elicit decisions that are value based), and whether they mean to think of valuation efforts as the summation of individual preferences or the product of group-based deliberation.

---

## Notes

1. A cautionary note: like any broad-stroke distinction, discussion of these two positions—the axiomatic and the relativistic—is meant to facilitate the reader’s grasp of a rich and varied literature; the border between the two approaches is less clear than my portrait implies.
2. The distinction between different ethics is not always clearly defined; Leopold’s ethic might be subsumed, for instance, by a natural ethic, in that maintaining a natural state may in some cases serve the maintenance of a system’s parts.
3. For a review of multiple ethics and their implications for defending value, see especially Armstrong and Botzler 1993 and Rolston 1999.
4. Much recent work on contingent valuation has abandoned WTP methods in favor of choice processes and the costing of observable (or revealed) behavior, such as the travel costs one invests to get to a wilderness area, national park, recreation facility, and so on.
5. Merchant (1992) similarly delineated identified egocentric, sociocentric, and biocentric value systems.

6. Many of these studies stem from the work of Tversky and Kahneman (1981) and of Kahneman, Slovic, and Tversky (1982).
7. I follow, here, Cohan and Shires's claim of "a linear organization of events" as a defining feature of a narrative (Cohan and Shires 1988, 52–53, quoted in Franzosi 1998). In the subsequent section, I elaborate further on what I mean by narrative.
8. Because there could be as many pathways as there are respondents, the survey designer seeks to characterize in detail only those pathways that depict major opinion streams held by respondents.

---

## References

- Armour, A. 1995. The citizens' jury model of public participation: A critical evaluation. In *Fairness and Competence in Citizen Participation*, ed. O. Renn, T. Webler, and P. Wiedeman, 175–87. Boston: Kluwer Academic Publishers.
- Armstrong, S., and J. Botzler. 1993. *Environmental Ethics: Divergence and Convergence*. New York: McGraw-Hill.
- Axelrod, L. 1994. Balancing personal needs with environmental preservation: Identifying the values that guide decisions in ecological dilemmas. *Journal of Social Issues* 50(3):85–104.
- Baron, J., and M. Spranca. 1997. Protected values. *Organizational Behavior and Human Decision Processes* 70:1–16.
- Brosius, P. 1999. Analysis and interventions: Anthropological engagements with environmentalism. *Current Anthropology* 40(3):277–309.
- Brown, T. C. 1984. The concept of value in resource allocation. *Land Economics* 60:231–46.
- Bruner, J. 1986. *Actual Minds, Possible Worlds*. Cambridge, Mass.: Harvard University Press.
- Callicott, J. B. 1984. Non-anthropocentric value theory and environmental ethics. *American Philosophical Quarterly* 21:299–309.
- . 1986. On the intrinsic value of nonhuman species. In *The Preservation of Species: The Value of Biological Diversity*, ed. B. G. Norton, 138–72. Princeton, N.J.: Princeton University Press.
- . 1995. Environmental ethics: Overview. In *The Preservation of Species*, ed. W. T. Reich, 138–72. Princeton, N.J.: Princeton University Press.
- Cohan, S., and L. M. Shires. 1988. *Telling Stories: A Theoretical Analysis of Narrative Fiction*. New York: Routledge.
- Costanza, R., et al. 1998. The value of the world's ecosystem services and natural capital. *Ecological Economics* 25:3–15.
- Crosby, N. 1995. Citizen juries: One solution for difficult environmental questions. In *Fairness and Competence in Citizen Participation*, ed. O. Renn, T. Webler, and P. Wiedeman, 157–74. Boston: Kluwer Academic Publishers.
- Dickson, B. 2000. The ethicist's conception of environmental problems. *Environmental Values* 9:127–52.
- Dunlap, R., and R. Scarce. 1991. The polls—poll trends: Environmental problems and protection. *Public Opinion Quarterly* 55:713–34.
- Dunlap, R., and K. Van Liere. 1978. The "new environmental paradigm." *Journal of Environmental Education* 9(4):10–19.
- Epstein, S. 1994. Integration of the cognitive and the psychodynamic unconscious. *American Psychologist* 49:709–24.
- Finucane, M. L., et al. 2000. The affect heuristic in judgments of risks and benefits. *Journal of Behavioral Decision Making* 13:1–17.
- Fiske, A. P., and P. E. Tetlock. 1997. Taboo trade-offs: Reactions to transactions that transgress spheres of justice. *Political Psychology* 18:255–97.
- Franzosi, R. 1998. Narrative analysis—or why (and how) sociologists should be interested in narrative. *Annual Review of Sociology* 24:517–54.
- Geertz, C. 1973. *The Interpretation of Culture*. New York: Basic Books.
- Gregory, R. 1999. Identifying environmental values. In *Tools to Aid Environmental Decision Making*, ed. V. H. Dale and M. R. English, 32–58. New York: Springer-Verlag.
- . 2000. Valuing environmental policy options: A case study comparison of multiattribute and contingent valuation survey methods. *Land Economics* 76(2):151–73.
- Gregory, R., et al. 1997. Decision pathway surveys: A tool for resource managers. *Land Economics* 73(2):240–54.
- Gregory, R., S. Lichtenstein, and P. Slovic. 1993. Valuing environmental resources: A constructive approach. *Journal of Risk and Uncertainty* 7:177–97.
- Gregory, R., D. G. MacGregor, and S. Lichtenstein. 1992. Assessing the quality of expressed preference measures of value. *Journal of Economic Behavior and Organization* 17:277–92.
- Habermas, J. 1979. *Communication and the Evolution of Society*. Translation and introduction by Thomas McCarthy. Boston: Beacon Press.
- Inglehart, R. 1995. Public support for environmental protection: Objective problems and subjective values in forty-three societies. *PS: Political Science and Politics* 28:57–72.
- Kahneman, D., and J. Knetsch. 1992. Valuing public goods: The purchase of moral satisfaction. *Journal of Environmental Economics and Management* 22:57–70.
- Kahneman, D., P. Slovic, and A. Tversky. 1982. *Judgment under Uncertainty: Heuristics and Biases*. New York: Cambridge University Press.
- Kahneman, D., and J. Snell. 1990. Predicting utility. In *Insights in Decision Making*, ed. R. M. Hogarth, 295–310. Chicago: University of Chicago Press.
- Kearney, A. R. 1994. Understanding global change: A cognitive perspective on communicating through stories. *Climate Change* 27:419–41.
- Keeney, R. L. 1992. *Value-Focused Thinking: A Path to Creative Decision Making*. Cambridge: Harvard University Press.
- Kellert, S. R. 1996. *The Value of Life: Biological Diversity and Human Society*. Washington, D.C.: Island Press.

- Kempton, W., J. Boster, and J. Hartley. 1995. *Environmental Values in American Culture*. Cambridge, Mass.: Massachusetts Institute of Technology.
- Kida, T., and J. F. Smith. 1995. The encoding and retrieval of numerical data for decision making in accounting contexts: Model development. *Accounting, Organizations, and Society* 20:585–610.
- Kraus, S. 1995. Attitudes and prediction of behavior: A meta-analysis of the empirical literature. *Personality and Social Psychology Bulletin* 21(1):58–75.
- Ladd, E. C., and K. H. Bowman. 1995. *Attitudes toward the Environment: Twenty-five Years after Earth Day*. Washington, D.C.: AEI Press.
- Leopold, A. 1966. *A Sand County Almanac: With Essays from Round River*. New York: Ballantine.
- Lockwood, M. 1999. Humans valuing nature: Synthesizing insights from philosophy, psychology, and economics. *Environmental Values* 8:381–401.
- Lutz, C. 1988. *Unnatural Emotions*. Chicago: University of Chicago Press.
- Merchant, C. 1992. *Radical Ecology*. New York: Routledge.
- Mitchell, R. C., and R. T. Carson. 1989. *Using Surveys to Value Public Goods: The Contingent Valuation Method*. Washington, D.C.: Resources for the Future.
- Nash, R. F. 1989. *The Rights of Nature*. Madison: University of Wisconsin Press.
- Norton, B. G. 1986. *The Preservation of Species: The Value of Biological Diversity*. Princeton, N.J.: Princeton University Press.
- . 1991. Thoreau's insect analogies: Or, why environmentalists hate mainstream economists. *Environmental Ethics* 13, 235–51.
- Oatley, K. 1994. A taxonomy of the emotions of literary response and a theory of identification in fictional narrative. *Poetics* 23:53–74.
- Payne, J. W., J. R. Bettman, and E. J. Johnson. 1992. Behavioral decision research: A constructive processing perspective. *Annual Review of Psychology* 43:87–131.
- Payne, J. W., J. R. Bettman, and D. A. Schkade. 1999. Measuring constructed preferences: Towards a building code. *Journal of Risk and Uncertainty* 19(1):243–70.
- Pennington, N., and R. Hastie. 1993. A theory of explanation-based decision making. In *Decision Making in Action: Models and Methods*, ed. G. Klein et al., 188–204. Norwood, N.J.: Ablex.
- Proctor, J. 1996. Whose nature? The contested moral terrain of ancient forests. In *Uncommon Ground: Rethinking the Human Place in Nature*, ed. W. Cronon, 269–97. New York: W. W. Norton and Co.
- Renn, O., T. Webler, and P. Wiedemann. 1995. *Fairness and Competence in Citizen Participation*. Dordrecht, Netherlands: Kluwer.
- Rimmon-Kenan, S. 1983. *Narrative Fiction: Contemporary Poetics*. London: Methuen.
- Ritov, I., and D. Kahneman. 1997. How people value the environment: Attitudes versus economic values. In *Environment, Ethics, and Behavior*, ed. M. Bazerman, D. Messick, and A. Tenbrunsel, 33–51. San Francisco: New Lexington.
- Rokeach, H. 1973. *The Nature of Human Values*. New York: Free Press.
- Rolston, H. I. 1988. *Environmental Ethics*. Philadelphia: Temple University Press.
- . 1994. *Conserving Natural Values*. New York: Columbia University Press.
- . 1999. Ethics and the environment. In *Ethics Applied*, ed. E. Baker and M. Richardson, 407–37. New York: Simon and Schuster.
- Sagoff, M. 1988. *The Economy of the Earth*. New York: Cambridge University Press.
- . 1991. Zuckerman's dilemma: A plea for environmental ethics. *Hastings Center Report* 21(5):32–40.
- . 1998. Aggregation and deliberation in valuing public goods: A look beyond contingent pricing. *Ecological Economics* 24:213–30.
- Satterfield, T. A. 1999. New methods to elicit and identify environmental values. Paper presented at the American Academy for the Advancement of Science Annual Meeting, Los Angeles.
- . 2001. In search of value literacy: Suggestions for the elicitation of environmental values. *Environmental Values* 10:331–59.
- Satterfield, T. A., and R. Gregory. 1998. Reconciling environmental values and pragmatic choices. *Society and Natural Resources* 11:629–47.
- Satterfield, T. A., P. Slovic, and R. Gregory. 2000. Narrative valuation in a policy judgment context. *Ecological Economics* 34:315–31.
- Shanahan, L., L. Pelstring, and K. McComas. 1999. Using narratives to think about environmental attitude and behavior: An exploratory study. *Society and Natural Resources* 12(5):409–19.
- Slovic, P. 1995. The construction of preference. *American Psychologist* 50:364–71.
- Slovic, P., J. Monahan, and D. G. MacGregor. 2000. Violence risk assessment and risk communication: The effects of using actual cases, providing instructions, and employing probability vs. frequency formats. *Law and Human Behavior* 24(3):271–96.
- Steel, B. S., et al. 1993. Conflicting values about federal forests: A comparison of national and Oregon publics. *Society and Natural Resources* 7(2).
- Stern, P., et al. 1995. Values, beliefs, and pro-environmental action: Attitude formation toward emergent attitude objects. *Journal of Applied Social Psychology* 25:322–48.
- Stern, P., and T. Dietz. 1994. The value basis of environmental concern. *Journal of Social Issues* 50(3):65–84.
- Stocker, M., and E. Hegeman. 1996. *Valuing Emotions*. New York: Cambridge University Press.
- Stone, C. 1987. *Earth and Other Ethics*. New York: Harper and Row.
- Suter, G. W. I. 1993. *Ecological Risk Assessment*. Boca Raton, Fla.: Lewis.
- Tversky, A., and D. Kahneman. 1981. The framing of decisions and the psychology of choice. *Science* 211:453–58.





# Cultural Capital and Sustainability Concepts in the Economics of Cultural Heritage

By David Throsby

---

## Introduction

Traditionally, the work of conservationists in the field of tangible cultural heritage<sup>1</sup> has covered a range of tasks, including identification, classification, certification, interpretation, protection, maintenance, and restoration. The decisions that they make concerning, for example, what counts as heritage or which items should be accorded privileged status (e.g., as listed buildings) have been based on their professional and technical expertise. Economists have recently begun to ask questions about the economic ramifications of such decisions. For example, Françoise Benhamou has pointed to the resource implications of the unconstrained enthusiasm for listing historic buildings in France (Benhamou 1998). Sir Alan Peacock has suggested that conservationists' control of the heritage policy agenda may be out of step with the preferences of the community whose taxes are financing the recommended policy measures (Peacock 1997).

At the same time, when economists themselves become involved in heritage matters, they have been accused by conservationists of adopting a narrow economizing attitude to heritage decisions, turning attention away from the essential cultural values of heritage toward a more market-driven approach. For example, Daniel Bluestone points out that programs for restoring and redeveloping historic sites are often driven more by an imperative to create incomes, employment, tourist revenues, and so on than by a desire to enhance intrinsic cultural worth; he argues that looking to financial outcomes to justify expenditure on such programs may compromise the very heritage values upon which the programs are based (GCI 1999, 20–21). Although an economist's approach to heritage is in fact more sophisticated than one simply focusing on financial revenues and costs, the criticism does have validity in highlighting the problems raised by the economic necessity of reducing all values to material terms.

The "Economics and Heritage Conservation" meeting organized by the Getty Conservation Institute in December 1998 showed that questions of value do indeed underlie these differing standpoints (GCI 1999). In broad terms, the meeting concluded that if it is possible to identify both the economic and the cultural values generated by, say, a particular heritage item, then it may be possible to reconcile the two positions. More particularly, the meeting discussion suggested that the concepts of cultural capital and sustainability could be used to link an economic approach to heritage with the essential cultural purposes that the conservation profession strives to pursue.

How might such a link be forged? Later in this paper, more detailed definitions and analyses will be given, but for these introductory purposes, the connection could be spelled out intuitively, as follows. We could characterize conservationists as interpreting heritage items as stores of cultural value—that is, as things that have been inherited from the past which are valuable in themselves and which yield value to those who enjoy them in one way or another, both now and in the future.<sup>2</sup> Economists in turn can readily comprehend that artifacts, artworks, buildings, sites, and so on have the characteristics of capital assets and that the depreciation, maintenance, restoration, and so on of such assets can be analyzed as economic processes.<sup>3</sup> Given that heritage as capital has some characteristics (such as the production of cultural value) that are different from those of other sorts of capital, it seems that a notion of "cultural capital" to describe heritage might be able to integrate its principal economic and cultural characteristics.

Moreover, both conservationists and economists are concerned with the long-term nature of decisions relating to significant capital items, invoking the notion of "sustainability."<sup>4</sup> This concept has specific connotations in an environmental context that relate especially to the preservation of natural assets for future generations; so, for example, the harvesting of fish stock is "sustainable" if the catch is controlled so that the total population of fish is maintained into the future. In more general usage,

a sustainable solution to a problem is one that is not a quick fix but is likely to provide a more permanent or lasting remedy. The antithesis of sustainability—namely, “unsustainability”—is also widely recognized. For example, a country’s rapid rate of economic growth in the short term might be described as unsustainable if it is not based on fundamental strength and is not likely therefore to be maintained over a longer period. It is thus not difficult to see that since the very same principles of long-term decision making, concern for future generations, and so on are important for the disciplines of both conservation and economics in their respective analyses of cultural heritage, the idea of sustainability could well provide a link between the economist’s and the conservationist’s approach to the problem.

The task of this paper, then, is to sharpen the analytical articulation of these two concepts—cultural capital and sustainability—in their application to the economics of cultural heritage, and to consider ways of making them operational so that they can be applied to real-world phenomena. The latter requirement means confronting problems of empirical measurement—i.e., how can we assess the economic and cultural value of heritage and of the services that heritage produces, and how can those values be incorporated into an empirical analysis of decisions relating to cultural heritage, such that sustainability principles are effectively served?

The layout of this paper is as follows: In the following section, under the heading “Cultural Capital,” the concept of cultural capital is analyzed in detail, beginning with definitional questions and then considering the place of this concept in an economic and a cultural discourse. In this discussion we look particularly at whether any parallels may be drawn between our formulation of cultural capital and concepts of natural capital used in ecological economics. Then in the next section, “Sustainability,” we discuss the definition and elaboration of sustainability in a heritage context, drawing again, where appropriate, on corresponding ideas in relation to environmental preservation and enhancement. We suggest that the most useful way to articulate the sustainability concept here is as a set of principles or criteria against which particular cases may be judged. Finally, in the section called “Application,” we look at prospects for ongoing work. The question of measurement is the most obvious one to be considered, with reference to methodologies for assessing both economic and cultural value. The sorts of criteria that might be used to select case studies for application of these various ideas are discussed.

---

## Cultural Capital

### Definitional Issues

The concept of capital in economics is almost as old as the discipline itself. In formal terms, capital can be defined as a stock of goods that gives rise to further goods and services over time. The principal form of capital identified in economics is *physical capital*, meaning plant, machinery, buildings, equipment, and so on, all of which provide a flow of services yielding other commodities that may be consumed or may themselves be capital items leading to still further commodities. Thus, for example, an automobile plant is a capital item yielding a flow of services that, when combined with other inputs such as labor, will produce further goods, namely cars. In this case the cars are themselves capital assets to the individuals who purchase them, because they, in turn, are combined with other inputs (gasoline, labor) to yield services of transport that enter the individuals’ final consumption.

In economics the concept of capital invokes the notion of investment, which is the process of adding to the capital stock. At the beginning of any time period, individuals, firms, or the economy as a whole are assumed to possess an endowment of capital goods, which may depreciate or deteriorate through wear and tear and which may be replaced or augmented by new investment during the time period under consideration.

Economists also identify two further forms of capital: human and natural capital. *Human capital* represents the accumulated education and experience embodied in people which enables them to be more productive. Investment in this form of capital implies education through on-the-job training, learning by doing, and so on, all of which yield future rewards in the form of improved productivity and higher earnings for the individual and for society. *Natural capital* refers to the stock of natural resources, such as air, land, water, and the life-supporting ecosystems that govern their operation. We shall be returning to the concept of natural capital later in this paper.

In considering the phenomenon of capital in economics, we must be clear about the distinction between stocks and flows.<sup>5</sup> The *stock* of capital, as its name suggests, refers to the quantity of capital in existence at a given time, measurable as the number or value of capital items in a given situation. This capital stock gives rise over time to a *flow* of services that, as noted above, may enter

final consumption immediately or be combined with other inputs to yield further goods and services. Take the historic town center of Dublin, for example, a precinct that has been redeveloped as a cultural and commercial center that preserves the architectural features of the original buildings. The collection of buildings and the relationships among them make up the capital stock, and the flow of services they provide can be seen in the continuing benefits enjoyed by those who visit the precinct or use it during their everyday lives. In any analysis of capital in economics, it is essential to identify whether the capital concept being used refers to a stock or a flow variable.

It should not be difficult to accept that tangible cultural heritage of the sort described above can be considered a form of capital. Heritage items such as a painting by Rembrandt or a historic building can be seen as assets: both required investment of physical and human resources in their original manufacture and construction; both will deteriorate over time unless resources are devoted to their maintenance and upkeep; and both give rise to a flow of services over time that may enter the final consumption of individuals directly (e.g., when people view the painting in a museum or visit the historic building) or that may contribute to the production of further goods and services (e.g., when the painting inspires the creation of new artworks or when the historic building is used as a commercial office space). In other words, heritage items can be interpreted as capital assets with the standard characteristics of ordinary physical capital in economics.

Is it sufficient simply to classify tangible heritage as physical capital, or is there something else about heritage items that distinguishes them from other items of physical capital? Recently, suggestions have been made that heritage items are members of a class of capital that is indeed distinct from other forms of capital; this class has been called *cultural capital*.<sup>6</sup> The distinction lies in the type of value that is embodied in these assets and is yielded by the goods and services they produce. A historic building such as Notre Dame Cathedral or the Taj Mahal is not just any building: certainly it has the characteristics of an “ordinary” building as an item of physical capital, but in addition, it has historical and other attributes that an “ordinary” building does not have. These attributes can be described as the building’s cultural value, and the same type of cultural value can be attributed to the flow of services it provides. This notion of the cultural value of certain goods and services such as heritage can be set alongside the more familiar concept of their economic

value. Later in this paper, we shall be more explicit about what comprises both economic and cultural value; for now it is sufficient to assume that cultural value can be measured according to a unit of account that plays a role comparable to that of a monetary scale in measuring economic value. It is also assumed that an item’s cultural value is separate from, though not unrelated to, its economic value.

Accepting these interpretations, then, we can provide a formal definition of cultural capital as an asset that embodies a store of cultural value, separable from whatever economic value it might possess; the asset gives rise to a flow of goods and services over time which may also have cultural value (i.e., which are themselves cultural goods and services). The stock of tangible cultural capital thus defined comprises cultural heritage as specified above. Intangible cultural capital exists in ideas, traditions, beliefs, and customs shared by a group of people, and it also includes intellectual capital, which exists as language, literature, music, and so on. In this paper, as noted above, we restrict attention to tangible cultural capital.

### Questions of Value

Bearing in mind that the value of an item of cultural capital may relate to its asset value as a stock of capital or to the value of the flow of services to which it gives rise, let us turn attention to the types of economic value attributable to heritage assets. We can distinguish between use and nonuse values. *Use value* refers to the direct valuation of the asset’s services by those who consume those services—the entry fees paid by visitors to historic sites, for example. *Nonuse value* refers to the value placed upon a range of nonrival and nonexcludable public-good characteristics<sup>7</sup> typically possessed by cultural heritage. In brief, these nonuse values may relate to the asset’s existence value (people value the existence of the heritage item even though they themselves may not consume its services directly); its *option* value (people wish to preserve the option that they or others might consume the asset’s services at some future time); and its *bequest* value (people may wish to bequeath the asset to future generations). These nonuse values are not observable in market transactions, since no market exists on which the rights to them can be exchanged, although their magnitude can nevertheless be evaluated, for example, by asking people how much they are willing to pay to ensure that these benefits will continue to be available to them. Because these values arise outside of market processes, they can be

referred to as examples of *nonmarket* values.

Taken together, the use and nonuse values defined above make up what we refer to as the *economic value* of a heritage asset or of the goods and services to which it gives rise, i.e., the value of these items as assessed by an economic analysis. It is important to note that economic value in this sense differs from *financial* value (“the bottom line”) since the latter does not include nonmarket effects. Nevertheless, both are expressed in the same terms, i.e., in monetary units.

The different types of economic values identified above can be illustrated with reference to Venice. A range of direct economic impacts can be attributed to this historic city, including the contribution of its cultural capital stock to the net value of the output of goods and services produced by the city’s economy. A significant proportion of these direct use values is generated by tourism, which provides the tangible revenue base upon which the local economy is sustained. In addition, Venice gives rise to all three of the nonmarket benefits noted above: people all over the world care deeply about the continued existence of Venice, even if they have never been there; many would be willing to pay something simply to preserve the option of visiting it at some time; and the city is surely regarded as part of Italy’s and the world’s cultural patrimony, which must be passed on intact to future generations. All of these use and nonuse values can be identified for Venice as a whole and, at a more specific level, for individual components of Venice, such as particular buildings or (collections of) artworks contained within its boundaries.

So much for the economic value of cultural capital. By definition, an item of cultural capital also embodies cultural value, and any valuation of the item as a stock of capital would, in principle, account for this value separately from its economic worth. Similarly, the cultural value of the flow of services it produces could, again in principle, be identified. What are the dimensions of the cultural value that might be embodied in or produced by an item of cultural heritage? Whether the approach to assessing cultural value is absolutist (Etlin 1996) or relativist (Connor 1992), certain elements might be identified as contributing to the aggregate cultural value of the item, including

- *aesthetic value*: beauty, harmony
- *spiritual value*: understanding, enlightenment, insight
- *social value*: connection with others, a sense of identity

- *historical value*: connection with the past
- *symbolic value*: objects as repositories or conveyors of meaning

To illustrate, the cultural value of Uluru (Ayer’s Rock) in Central Australia to both indigenous and nonindigenous people can be seen to comprise all five of these characteristics: it is a beautiful and spiritual place, providing a sense of identity to both the traditional owners and to other Australians and providing strong historical links and deep symbolic value within Aboriginal culture.

If the economic and cultural value of cultural capital can be separated, what is the relationship, if any, between them? Consider first the asset value of an item of tangible heritage such as a building of historical significance. The asset may have economic value that derives simply from its physical existence as a building without regard to its cultural worth. But the economic value of the asset is likely to be augmented, perhaps significantly so, because of its cultural value. Thus we can see a causal connection: cultural value may be a significant determinant of economic value. So, for example, individuals may reveal their willingness to pay for the embodied cultural content of this asset by offering a price higher than that which they would offer for the physical entity alone. In other words, a heritage building may embody “pure” cultural value, according to the assumed scale proposed earlier, and also have an economic value as an asset derived from both its physical and its cultural content. Other forms of tangible cultural capital may be construed similarly, although the significance of the elements may differ. Artworks such as paintings, for example, may derive much of their economic value from their cultural content, since their purely physical worth is likely to be negligible (a piece of canvas, some bits of wood).

Likewise, the economic and cultural value of the flow of services produced by the cultural asset would likely be closely related. In the case of the historic building, for example, its use value, measured as the entrance fees paid by visitors, would be expected to be greater the higher the cultural value people place on the experience of visiting it (other things being equal). Its nonuse values would be similarly related to the building’s perceived cultural worth. Thus the overall economic value of the flow of services provided by the asset would be expected in general to be closely correlated with its cultural valuation, even though those economic and cultural values can be separately defined.<sup>8</sup>

Nevertheless, despite the likelihood of correlation between economic and cultural value when assessed for some particular heritage item, there is no reason to suppose the correlation will be perfect. Indeed, instances can be readily imagined where high cultural worth is associated with a low economic valuation, and vice versa.<sup>9</sup>

### Asset Management

Bearing in mind that “value” when applied to cultural capital embraces both economic and cultural connotations, we can ask how far we can go in applying conventional asset management techniques and investment theory to the assessment of cultural heritage. To do so requires some further terminology and concepts.

Consider first the notion of investment. A capital asset is created by investment; the capital cost of the asset includes the costs of all the resources used up in its manufacture. An asset already in existence has a value that depends on a variety of factors, including its age, its condition, its original cost, and so on. Accountants have various ways of assessing the value of already existing assets that need not concern us here.<sup>10</sup>

Next consider an asset’s earnings. An asset yields a time stream of benefits and costs into the future: the benefits are represented by the value of the services the asset provides, the costs by the value of resources used up in producing those services, including the costs of maintaining the asset itself. The flow of net benefits into the future can be represented as a *rate of return* to the initial capital cost or to the current asset value of the capital item by expressing the (annual) net benefits as a percentage of the capital value. But it has to be remembered that a dollar in a year’s time is not the same thing as a dollar now. This is so for two reasons. First, people prefer present over future consumption and so would rather have a dollar now than to have to wait a year for it; in other words, people would need more than a dollar in one year’s time to make it an amount equivalent to a dollar today. Second, if a dollar now is invested at the going rate of interest, it will have grown to more than a dollar one year from now; hence again, future monetary amounts are equivalent to something less when expressed in terms of their present value. Therefore, in any investment appraisal, future benefits and costs have to be discounted to bring them to equivalent terms at time zero (the present). The *discount rate* is the rate at which this discounting occurs. Economists distinguish two different concepts of the discount rate, which correspond to the two reasons for the differ-

ence between present and future value. The first measures the preference of an individual or of society for consumption now rather than in the future. This is called the *individual or social time preference rate*; the higher the rate of discount, the greater the preference of the individual or society for consuming now rather than later, other things being equal. The second concept is the *opportunity cost rate*, defined as the best alternative risk-free rate of return available to the investor at time zero. This rate reflects the fact that the initial capital investment or value of the asset at time zero could have been invested elsewhere and would have yielded a rate of return; thus an opportunity cost is incurred by having these funds tied up in the asset under consideration. There has been a long and somewhat inconclusive debate among economists as to which of these is the “correct” discount rate to use in evaluating investment projects, how large or small it should be in particular contexts, and, indeed, whether some entirely different basis for comparing present and future values should be found. Nevertheless, whatever method of discounting is used, when the future time stream of net benefits yielded by an asset is brought back to a single sum measured at time zero, the resulting amount is called the *net present value* (NPV) of the asset’s earnings.

Armed with all these concepts, economists and accountants have developed techniques for assessing whether or not a decision to invest in a particular capital asset or project is warranted. There are several methods for evaluating capital investment decisions, including

- *the payback method*—that is, how long does it take for the asset’s earnings to repay its initial capital cost?
- *the benefit-cost ratio and NPV method*—that is, do aggregate net benefits, suitably discounted, exceed the capital cost?
- *the internal rate of return method*—that is, what discount rate just matches aggregate discounted net benefits with the initial capital cost?

All of these methods fall into the general category of investment appraisal techniques called *cost-benefit analysis*, widely used by economists in analyzing and informing investment decisions in the private and public sectors.

There seems no reason why these methods could not, in principle, be applied to the appraisal of cultural capital. Heritage items such as historic buildings have an existing asset value, require real resources in their maintenance, and yield flows of benefits into the future. Thus the evaluation of a heritage project involving, say, restoration of a site could aim to identify all the market and non-

market benefits and costs involved and then use one or another of the techniques outlined above to compare investment in this project with other competing heritage projects or with other (nonheritage) alternative investment opportunities. It is important to repeat, however, that since cultural capital is distinguished from ordinary physical capital by the cultural value it generates, evaluation methods applied to heritage projects should be focused on both the economic and the cultural value of the projects under study. This requirement becomes an empirical and measurement issue to which we shall return below.

### Parallels with Natural Capital

The definition of cultural capital has much in common with the way in which natural capital was defined at a similar stage in its development. Indeed, it is useful to review the development of that definition in the ecological economics literature. The origins of considering “the environment” as capital go back, in fact, to the great nineteenth-century political economists such as David Ricardo and Thomas Malthus, who were concerned with the contribution of agricultural land to the production of goods and services in the economy. But contemporary formulation of the concept of natural capital to describe “the free gifts of nature” dates from the late 1980s and the emergence of the subdiscipline of ecological economics during the 1990s. In a series of contributions,<sup>11</sup> the elements of natural capital have been identified and are now generally agreed to be the following components: (1) renewable natural resources such as fish and forest stocks, (2) nonrenewable resources such as oil and mineral deposits, (3) the ecosystems that support and maintain the quality of land, air, and water; and (4) the maintenance of a vast genetic library, referred to as biodiversity. Within these concepts we can distinguish between the stock of natural capital (the fish and forest populations, the mineral deposits, etc.) and the *flow* of environmental services they provide (the harvesting of fish and timber, the recycling of waste materials, erosion control, aesthetic services of landscape, etc.). In some formulations, the flow of services is referred to as *natural income*, reflecting the capital/income distinction discussed above.<sup>12</sup>

The parallels between natural and cultural capital now start to take shape. Tangible cultural capital that has been inherited from the past can be seen to have something in common with natural resources, which have also been provided to us as an endowment; natural resources

have come from the beneficence of nature, cultural capital has arisen from the creative activities of humankind. Both impose on us a duty of care, the essence of the sustainability problem, which will be discussed below. Furthermore, a similarity can be seen between the function of natural ecosystems in supporting and maintaining the “natural balance” and the function of what might be referred to as “cultural ecosystems” in supporting and maintaining the cultural life and vitality of human civilization.<sup>13</sup> Finally, the notion of diversity, so important in the natural world, has a perhaps even more significant role to play within cultural systems. It is a characteristic of most cultural goods that they are unique, and this applies particularly to tangible heritage; all original artworks, for example, are differentiable from all others, all heritage buildings and sites are individually identifiable as distinct. Thus, cultural diversity is perhaps even more far-reaching than is diversity in nature. It has often been noted that diversity is a fundamental characteristic governing the functioning of culture in society (WCCD 1995); hence, much of the analysis of biodiversity might be applicable to a consideration of cultural heritage.

Apart from the matter of sustainability, there are two important issues raised by the debate over natural capital which are of relevance in the heritage context. The first relates to valuation of capital stocks. In natural capital theory, the valuation question has been a matter of considerable controversy. A recent attempt at quantifying global natural capital by Costanza and colleagues (Costanza et al. 1997) attracted much criticism from commentators (El Serafy 1998; Toman 1998), who objected to alleged double counting and to the apparently infinite price being placed on several items. Nevertheless, the exercise was fruitful if for no other reason than that it focused attention on the difficulty of, as El Serafy put it, pricing the invaluable (El Serafy 1998, 25). Similarly, efforts to value the stock of cultural capital are likely to be fraught with danger—a danger that will be compounded by the fact that not only an economic measure but also some form of cultural valuation must be sought.

The second issue relates to the relationship among different forms of capital and to the extent to which one is substitutable for another.<sup>14</sup> In the natural capital debate, a great deal of attention has been devoted to the possibilities or otherwise for substituting physical for natural capital. Essentially the argument is that if human-made capital can produce the same goods and services as natural capital, then we need not be so concerned about maintaining levels of natural capital in the

future (e.g., preserving stocks of exhaustible resources), since physical capital can be substituted for it. Positions taken in this debate range from zero substitutability at one end all the way through to perfect substitutability at the other. The likely consensus is that while some aspects of the services provided by natural capital may be replaceable by manufactured capital, there are other aspects that cannot be.<sup>15</sup> Thus, for example, while new human-made technologies may go some way toward replacing natural energy sources, it is difficult to see how species loss could be made up through additions to physical capital, especially under conditions of uncertainty as to the future benefits that different species might provide.

In the case of cultural capital, provision of the *economic* functions of cultural assets is readily imaginable through substitution by physical capital; the services of shelter, amenity, and so on provided by a historic building could as well be provided by another structure without cultural content. However, since, by definition, cultural capital is distinguished from physical capital by its embodiment and production of *cultural* value, there would be expected to be zero substitutability between cultural and physical capital with respect to its cultural output.<sup>16</sup>

---

## **Sustainability**

### **Definitional Issues**

The concept of sustainability is most often invoked in the context of the environment, where the term *sustainable* is generally linked with the word *development*. *Sustainable development* marries the ideas of sustainable *economic* development, meaning development that will not slow down or wither away but will be, in some sense, self-perpetuating, and *ecological* sustainability, meaning the preservation and enhancement of a range of environmental values through the maintenance of ecosystems in the natural world. Furthermore, the term *sustainable development* embraces an interpretation of “economic development” that supersedes former notions of economic growth measured only in terms of increases in per capita GDP; sustainability in this context embraces the wider concept of “human development,” focused on the individual as both the instrument and the object of development and measured by a variety of indicators of quality of life and standards of living that go well beyond measuring simply material progress.

Most thinking and writing about sustainable development over the last decade acknowledges its debt, explicitly or implicitly, to the definition of the term put forward by the World Commission on Environment and Development (the Brundtland Commission), which specified sustainable development as “development that meets the needs of the present without compromising the ability of future generations to meet their own needs” (WCED 1987, 43). A subsequent United Nations commission, the World Commission on Culture and Development, which reported in 1995, carried these developmental ideas through to the arena of cultural development, where, again, the long-term needs of future generations for access to cultural resources can be seen as important (WCCD 1995).<sup>17</sup>

It is apparent from the accepted definition of sustainable development that a key element of this concept is equity in the treatment of different generations over time. The term *intergenerational equity*, or *intertemporal distributive justice*, is used to refer to fairness in the distribution of welfare, utility, or resources between generations. Although the principles of intergenerational equity can be applied to relations between any series of generations at any time, practical interest in it has focused, not surprisingly, on the concern among those of us alive today for the well-being of future generations. Intergenerational equity can be considered in relation to cultural capital because the stock of cultural capital is what we have inherited from our forebears and what we will hand on to future generations. Intertemporal equity issues arise in regard to access to that capital; in fact, it may be suggested that equity of access to cultural capital should be regarded as just as important as equity in the intergenerational distribution of benefits from any other sort of capital.

We take up a more detailed consideration of intergenerational equity as it relates to cultural capital in the next section.

### **Intergenerational Equity and Dynamic Efficiency**

Economists have defined intergenerational equity with reference to the maintenance of an equal level of welfare or utility between generations, expressed as per capita consumption or as endowment of resources or capital stock (Young 1992). Prima facie, therefore, the intergenerational equity dilemma is a classic intertemporal allocation problem—that is, a choice between present and future consumption. Casting this problem as one involv-

ing fairness or justice makes some economists uneasy, because of their unwillingness to make or assume value judgments on behalf of others; such hesitancy derives from a view of economics (especially neoclassical economics) as an objective, or value-free, science. So some economists have framed the intertemporal resource allocation question as one of efficiency rather than of equity,<sup>18</sup> requiring maximization of the net present value of benefits that the resources generate (Tietenberg 1996, 26). In a series of papers, Solow and Hartwick have shown that if the net income, or “rent,” from natural resources can be invested in a certain way, efficient growth paths for an economy can be achieved (Solow 1974, 1986; Hartwick 1977, 1978a, 1978b). Pearce and Atkinson carry this proposition further by developing a sustainability test for an economy that requires the total capital stock (physical plus natural) to remain constant over time (Pearce and Atkinson 1993).<sup>19</sup>

However, framing the problem of intergenerational resource allocation in this way raises difficulties, in particular the proper choice of discount rate to apply to future net benefit streams.<sup>20</sup> Even if the conceptual problems of whether the rate is a time preference or an opportunity cost indicator are solved, the determination of a single number to encapsulate the complex processes involved is something of a tall order. But, more important, it can be argued that seeing intertemporal resource allocation solely as an efficiency question does not dispose of the equity issue entirely. For example, any positive discount rate, however low, will mean that some future benefits will be effectively reduced to zero, inevitably giving what many would regard in ethical terms as undue weight to the preferences of the present generation. Thus, there is an inescapable question relating to the fairness of alternative outcomes that cannot be dealt with by an analysis that looks only at efficiency.

There are several ways in which the ethical basis of intergenerational judgments can be approached. A utilitarian view might look to the maximization of total social utility, where individuals’ ethical positions were reflected in the measure of their own welfare; in such a case, admitting altruism, disinterested demand, bequest values, and other such variables into individual utility functions would allow the self-interest of people alive today to incorporate their interest in the well-being of later generations. Alternatively, a contractarian approach following Rawls might be proposed, in which members of future generations are given equal weight in Rawls’s “original position”—that is, the vantage point from which the

choice of a social welfare function is viewed (Rawls 1972; Page 1977, 200–206; Becker 1982). Nevertheless, despite the theoretical appeal of these sorts of paradigms, they hardly provide operational decision rules to guide social choice when intergenerational equity problems arise.

The foregoing discussion has been framed in terms of intergenerational issues in the treatment of natural resources. How do those issues fall out when applied to cultural capital? To begin with, we can note that both the Hartwick-Solow and Pearce-Atkinson models assume perfect substitutability between natural and physical capital. However, when it comes to cultural capital, this assumption will often not hold, as we have noted already. Indeed, Solow himself concedes that “it makes perfectly good sense to insist that certain unique and irreplaceable assets should be preserved for their own sake; nearly everyone would feel that way about Yosemite or, for that matter, about the Lincoln Memorial, I imagine” (Solow 1994, 24).

Moreover, the critical difference between cultural and other forms of capital lies in its generation of cultural as well as economic value. Thus, the application of efficiency criteria to intertemporal investment decisions in cultural capital raises the prospect of a dual evaluation of the time stream of benefits, with both economic and cultural benefits having to be considered and with possibly different discount rates for each. For economists, the identification of use and nonuse values and their conversion to present-value terms, once the discount rate issue is resolved, is a straightforward matter. For conservationists, in contrast, the identification and measurement of cultural value and its aggregation into the equivalent of a net present value of cultural worth present formidable conceptual and operational difficulties. For both economists and conservationists, there may ultimately be a further choice: if economic and cultural valuations produce different rankings of projects, some means of trading off the different benefits will have to be considered if resources are sufficient to allow only a subset of the projects to be pursued.

Turning to equity issues in the process of resolving intergenerational problems, we can see a closer parallel between natural and cultural capital. We have mentioned this already in the context of fairness in access to cultural resources, which can be seen in the same terms as access to the benefits provided by natural resources. In a wider context, just as the maintenance of natural capital is regarded as essential to the achievement of economic and social objectives in a resource-using world, so also might



the maintenance and accumulation of cultural capital be seen as critical to the same objectives. Again, ensuring that future generations are not denied the cultural underpinnings of their economic, social, and cultural life as a result of our short-sighted or selfish actions now is a matter of fairness for which the present generation must accept a moral responsibility.

### **The Application of Sustainability Principles to Cultural Capital**

While intergenerational equity is a key element of sustainability, the long-running debate about ecologically sustainable development has indicated that other criteria need to be taken into account in making the concept relevant and operational. Therefore, let us now broaden the scope of sustainability to incorporate other aspects of this concept and consider their application to cultural heritage. An appropriate way for us to proceed will be to define a set of principles covering the significant criteria to be taken into account and to consider how the management of cultural heritage might be evaluated in the context of those principles. In this section, such a set of criteria is proposed which, it is hoped, can form the basis for judging sustainable cultural asset management and investment decisions in subsequent real-world application. The suggested criteria may be interpreted as specifying the requirements to which heritage decisions should conform if they are to lead to sustainable outcomes. Without loss of generality, these decisions may be characterized as involving investment in projects relating to the creation, preservation, restoration, renovation, classification, maintenance, reuse, interpretation, or whatever else, of cultural capital. It is intended that these criteria should apply equally within economic and cultural discourses and, indeed, that they should provide a bridge between the two.

The suggested criteria are as follows:

#### **GENERATION OF TANGIBLE AND INTANGIBLE BENEFITS**

As we have noted, cultural capital generates a time stream of benefits that provide the rationale for the investment project under consideration. A generalized cost-benefit approach may be taken in order to estimate the overall impact of the project. In this assessment, sustainability would require the analysis of net benefits to take account of *both* use *and* nonuse values, and of both economic and cultural value generated by the project.

If the alternative to investment in the project is investment in another project, the two projects should be evaluated as far as possible on the same basis. If the alternative is not to undertake the investment project, then the assessment should be based on a comparison of the with- and without-project situations.

#### **INTERGENERATIONAL EQUITY**

This principle requires that the interests of future generations be acknowledged. This acknowledgment might be pursued in several different ways. In quantitative terms, respect for intergenerational concerns might suggest adoption of a lower discount rate than might otherwise be accepted on time-preference or opportunity-cost grounds in the process of reducing both economic and cultural benefit streams to present-value terms. In qualitative terms, the issue of fairness itself should be explicitly considered in terms of the ethical or moral dimensions of taking account of the likely effect of the project on future generations.

#### **INTRAGENERATIONAL EQUITY**

Heritage decisions have significant effects on the welfare of the present generation. Consideration should be given to the distributional impacts of the costs of the investment project under study, in case a regressive incidence can be identified. Furthermore, intragenerational equity also refers to equity in access to the *benefits* of cultural capital across social classes, income groups, locational categories, and so on. If serious inequities are identified, the possibility of corrective or compensatory action might be raised, if indeed such action is feasible. Overall, in regard to this criterion, a sustainable project will be one leading to no adverse distributional consequences, in either economic or cultural terms, with respect to the incidence of either its costs or its benefits.

It might also be suggested that an intragenerational equity issue arises in the processes involved in actually making the investment decision. It may be appropriate for stakeholders affected by the decision to have some input into these processes. This concern raises the matter of empowerment of those whose interests are affected by heritage decisions; general considerations of sustainability would suggest attention to the fairness of decision-making procedures in this context.

#### **MAINTENANCE OF DIVERSITY**

Just as biodiversity is seen as significant in the natural world, so also is cultural diversity important in maintaining cultural systems. The diversity of ideas, beliefs, tradi-

tions, and values yields a flow of cultural services that is quite distinct from the services provided by the individual components. Indeed, diversity could be seen as one of the most important attributes of cultural capital in the large, because it has the capacity to yield new capital formation. For example, to the extent that creative works are inspired by the existing stock of cultural resources, a greater diversity of resources will lead to the creation of more varied and more culturally valuable artistic works in the future. Thus, assessment of specific investment projects should pay attention, in terms of this principle, to the contribution to cultural diversity that the project is likely to make.

#### PRECAUTIONARY PRINCIPLE

As a general proposition, the precautionary principle states that decisions that may lead to irreversible change should be approached with extreme caution and from a strongly risk-averse position, because of the imponderability of the consequences of such decisions. In the natural world, this principle is invoked in regard to decisions that might result, for example, in the extinction of species. Similarly, the destruction of an item of cultural heritage is a case of irreversible loss, and the precautionary principle should again be applied. The principle does not assert that such decisions are never to be taken but, rather, that it is appropriate to exercise a higher level of care in cases where irreversibility is involved, while bearing in mind the other principles of sustainability that assist in determining the decision.

#### RECOGNITION OF INTERDEPENDENCE

Finally, an overarching principle of sustainability is the proposition that no part of any system exists independently of other parts and that the interconnectedness between specific items of cultural capital and the benefits they bestow should be examined in any project appraisal. In other words, the role of heritage items as components of what might be termed the cultural infrastructure of a city, a region, or a country should, according to this principle, be explicitly recognized and its importance be identified as a distinct element of the analysis.

In summary, the above set of principles provides a checklist of criteria against which to evaluate decisions relating to cultural capital investment projects, so as to assess the degree to which they are sustainable. The criteria could be used to rank heritage projects or to compare them with projects in other (nonheritage) areas. In the final section of this paper, we consider prospects and proposals for empirical application of these criteria to actual case studies.

---

## Application

### The Task Ahead

The concept of cultural capital as a means of representing heritage and the principles of sustainability that we have enumerated above provide a solid theoretical foundation that links the economist's and the conservationist's approaches to heritage decisions. The next step is to give these theoretical ideas some practical reality. How can they be made operational in a way that continues to recognize the importance of both an economic and a cultural interpretation of heritage in the real world of conservation?

In order to focus the analysis, let us suppose that the task ahead of us—that is, the decision to be made—concerns a project. For example, a project might involve:

- the restoration of an artwork; the work might be a freestanding single work, such as an old master painting, it might be a collection of artworks, or it might be an immovable work or works integral to a building or site, such as the frescoes in the St. Francis Basilica in Assisi or rock paintings in Arnhem Land
- the restoration or redevelopment of a historic building, perhaps also involving a decision as to its possible listing
- the redevelopment (and possible reuse) of a historic or cultural site, precinct, location, urban space, and so on

Other examples of projects might be imagined. In each case, the focus of the project is an item or collection of items of cultural capital, and the project itself can be conceived of as a process of investment of economic resources and conservation expertise—that is, an investment involving both economic and cultural inputs. The investment might be interpreted as maintenance investment (as in the case of restoration or preservation) or as new investment (as in a reuse or redevelopment project) or as both. The questions to be asked can be framed as follows:

- What are the economic and cultural returns to that investment?
- Does the project meet the sustainability criteria?
- Do the economic and cultural returns justify proceeding with the project, in comparison with alternative ways of using the same economic and cultural inputs?

To address these questions, we need to develop

measures of the economic and cultural value of the project. Possible methodologies are discussed below. We note at once that techniques applicable to an assessment of the economic returns to heritage projects are well developed, being readily adaptable from other areas such as the evaluation of environmental amenity. However, suitable methodologies for systematic cultural assessment of heritage are more speculative. We deal with the economic and cultural assessments in turn, and then we consider how the sustainability principles enunciated above can provide a means for integrating the two.

### **Methodologies for Economic Assessment**

We can distinguish three categories of economic effects of the project which have to be measured: the capital costs, the use values, and the nonuse values.

The *capital costs* are the measurable opportunity costs of all resources committed up front to the project. In a project involving the restoration of an artwork, these costs might cover the time allocation of experts and technicians, the costs of materials, and so on. For an urban redevelopment project, significant construction costs might be involved.

An issue arises in connection with the treatment of ongoing maintenance costs following an initial investment. For example, the cleaning of St. Paul's Cathedral in London involved not just the once-over cleaning and restoration cost (the "capital cost" of the project) but also an annual and ongoing level of maintenance to ensure that the benefits of the initial investment would not be dissipated over time. In some cases, such continuing maintenance costs can be netted out of the time stream of benefits in the overall project appraisal; in other cases, it may be appropriate instead to include the present value of the time stream of maintenance costs into the initial capital cost of the project.

The *use values* of a heritage project comprise the values of all identifiable directly used goods and services that the project generates. When these outputs are sold to consumers, the use values can be measured as the expected total net revenue from sales; thus, for example, entrance charges levied on visitors to a historic site, net of administration and other operating costs, could be taken as one of the use values arising from a project to restore or redevelop the site. Similarly, the rental value of housing or other property in a historic town center project could be taken as one of the values-in-use of such a project.

We have already noted that *nonuse values* are likely

to form an important part, and perhaps the most significant component, of the economic value created by cultural heritage. It is important, then, to pay particular attention to the methodologies for assessing such effects. Three methodologies for assessing demand for nonmarket goods can be discussed: contingent valuation methodology (cvm), travel cost assessments, and hedonic pricing.<sup>21</sup>

### **CONTINGENT VALUATION METHODOLOGY**

cvm is one of the most widely used means of measuring nonmarket benefits in economic analysis.<sup>22</sup> It involves asking people their willingness to pay (wtp) for the benefits received or their willingness to accept compensation for their loss. The asking may take place under quasi-experimental conditions or, more commonly, may be administered through sample surveys of individuals drawn from the population of those experiencing the benefit in question. Thus, for instance, the nonuse value of a community cultural center or museum in a local area might be assessed on the basis of a survey of a sample of residents of the area. The survey might be conducted by telephone, mail, or personal interview. Respondents might be asked hypothetically to indicate the maximum financial contribution they would make to a fund to support the cultural center, or they might be asked whether or not they would contribute a fixed amount to such a fund. Either way, an analyst could use the results to estimate a hypothetical demand function for the nonuse benefits of the center.

There are a number of biases that may affect responses in cvm studies. The most obvious is the so-called "free-rider problem"—that is, people have an incentive not to reveal their true preferences for a public good if they know they cannot be excluded from enjoying its benefits once it is provided. In other words, individuals can escape payment by concealing their true wtp and yet still enjoy the benefits of consumption. Other biases may arise through the hypothetical nature of the questions, the possibility that responses may be based on insufficient or incorrect information, and the difficulties of ensuring that responses on single issues are consistent with an individual's overall budgetary position.<sup>23</sup> There are ways of circumventing these biases, or at least of mitigating their effects, through careful experimental design. For example, the free-rider problem may be controlled for by deliberately providing respondents with incentives to understate or overstate their wtp through altering their assumed liability to pay their nominated amount; by these means,

those respondents who free-ride can be distinguished from those who do not, and an estimate can be made of any bias due to this effect.<sup>24</sup>

The use of *cvm* was given some endorsement by the findings of an expert panel appointed by the U.S. National Oceanic and Atmospheric Administration to review the applicability of the technique in determining liability claims following the Exxon Valdez oil spill in Alaska in 1989. The panel, cochaired by Nobel laureates Kenneth Arrow and Robert Solow and including Edward Leamer, Roy Radner, Paul Portney, and Howard Schuman, found that “*cv* studies can produce estimates reliable enough to be the starting point of a judicial process of damage assessment, including lost passive-use values,” provided that such studies are carefully carried out, with due attention paid to the biases and other problems affecting the technique (Arrow et al. 1993).

Overall, it can be said that since the nonuse values from cultural heritage are very similar in kind to those arising from environmental amenity, the fact that many successful applications of *cvm* in the environmental sphere have now been carried out augurs well for the further application of the same techniques in the heritage field.<sup>25</sup>

#### TRAVEL COST METHODS

Individuals may reveal how much they value the benefits provided by an environmental or cultural site by the amount they are prepared to pay in making the journey to visit it. Studies have been carried out on visitors to particular sites, asking how much time they spent traveling to them and what financial outlays were involved. From the results for many respondents, a demand curve for the benefits of the site can be established. There are, however, a number of difficulties with this approach. Not all sites require a lot of traveling to visit them, and often multiple purposes are involved in the trip: for example, how does one allocate the cost of visiting Paris between the Louvre, the Eiffel Tower, and the Pompidou Center? Furthermore, even if reasonable estimates can be made by these methods, they would seem to relate more to direct use value (even though not accruing directly to the site in question) rather than to nonuse values. Thus, the application of travel cost methods in the present context would appear to be limited.

#### HEDONIC PRICING

Hedonic pricing approaches are based on indirect inference of the value of nonmarket effects from market data. For example, the costs of aircraft noise in an urban envi-

ronment or the benefits of water views can be inferred from analysis of house prices, in situations where all other contributory factors can be held constant. Such approaches have some potential for application to heritage projects, but their use is limited to situations in which a reasonably wide spread of market data can be found. So, for example, it might be possible to assess the influence of heritage values on property prices, including the effects of listing, by these means. An illustration is the study by Moorhouse and Smith, who investigated the influence of architectural styles on the prices of nineteenth-century terrace houses in Boston (Moorhouse and Smith 1994). Another application is that of Chanel and colleagues, who used hedonic methods to analyze the auction prices of artworks (Chanel, Gerard-Varet, and Ginsburgh 1996). Despite the validity of such studies in terms of what they set out to do, they suffer from the fact that, again, they essentially measure private, individual benefit rather than wider public-good effects.

Having outlined the measurement techniques available to assess the economic benefits and costs of heritage projects, we should note finally that the estimates made can be drawn together within a standard cost-benefit framework, as foreshadowed in the previous section. That is, the results of the economic analysis of a specific heritage project could in principle be represented in terms of any of the standard summary measures listed earlier—as a *NPV* estimate, an internal rate of return, a cost-benefit ratio, and so on.

It is important to be clear as to the distinction between the marginal benefit yielded by the project and the total benefit of the heritage item itself. An illustration should make this clear. Suppose the project is the restoration of the Sistine Chapel in the Vatican. An economic evaluation of the project would look at the costs involved in the restoration work and at the additional benefit the restoration would bring over and above the benefits yielded by this heritage item in the absence of restoration. In other words, the relevant benefit estimate with respect to this project is not the *total* use and nonuse value of the Sistine Chapel but, rather, the *marginal* benefits due to the restoration project—that is, how much additional benefit, attributable to the restoration work, is gained? Such marginal use benefit might be represented, say, by additional revenue generated because more visitors come to see the restored work. Marginal nonuse benefit might be represented by increases (if any) in general *WTP* for existence, option, and bequest values following the restoration.

## Methodologies for Cultural Assessment

It has been a theme of this paper that, in parallel with any assessment of the economic value of cultural heritage, an assessment of the cultural value of the project must be carried out, and that the cultural evaluation should be accorded, in some sense, an equal weighting with the economic analysis. We suggested earlier that, in principle, a “cultural cost-benefit analysis” might be imagined, where time streams of cultural benefits might be compared with the cultural resources devoted as inputs to the project.

To move from the theoretically plausible to the operationally feasible in this respect is a sizable jump, because, as we have already noted, no simple or universal metric for representing cultural value is available in the same way as money can be used as a means of aggregating economic worth. A clear message arising from the December 1998 meeting on economics and heritage conservation at the Getty Conservation Institute was that conservationists and culturalists need to develop systematic approaches to assessing cultural value. The report of the meeting noted that “the cultural disciplines and conservation professionals were challenged [by the discussion] to elaborate on existing tools and devise additional tools to evaluate noneconomic, cultural values. It was observed that the culturalist fields lack a unifying body of theory regarding values or the role of conservation in society” (GCI 1999, 15).

It may prove most productive, as foreshadowed earlier, to approach the question of assessing cultural value by trying to deconstruct the aggregate concept of cultural value into its constituent elements. If so, it may then be more plausible, with respect to any project, to provide an evaluation in terms of specific criteria or components of value, such as the aesthetic, spiritual, historic, and other characteristics of the project. It is difficult to comprehend quantitative scales against which such evaluations might be made, but it is rather easier to imagine qualitative measurement methods that might have some claim to unambiguous definition. For example, it might be possible to agree upon ratings according to levels of significance, importance, and so on, especially if they are assessed in comparative terms (object A is “more significant” against a criterion of, say, historical importance than object B).

Some illustration of these sorts of approaches may in fact be drawn from the cultural economics literature. Frey and Pommerehne derived rankings of the “quality” (read “assessed cultural value”) of visual artists’

work by reference to consensus judgments of experts, and they used the results as an explanatory variable in a demand equation for artworks (Frey and Pommerehne 1989, 81–100). The present author disaggregated the notion of the “quality” (again, read “assessed cultural value”) of theater performances into several criteria, and he found that consistent judgments of consumers could be measured against qualitative scales (Throsby 1990). There may be scope in the assessment of the cultural value of heritage to apply somewhat similar methods to gauging the consensus views either of experts or of consumers more generally.

## Integrating Economic and Cultural Assessments

The economic and cultural assessments carried out as discussed above provide much of the information necessary to assess the project against the sustainability criteria put forward in the previous section on sustainability. It would be appropriate for these criteria to be applied one by one to the project. In some cases, additional information may be needed: for example, an assessment of distributional effects in terms of the intragenerational equity principle might require a range of data on the project’s possible impacts. In some cases, perhaps, the required information may be too difficult or too costly to acquire, and some corners may have to be cut. In the end, it has to be acknowledged that sustainability is not a black-and-white concept but a matter of degree, and that assessing the extent to which a particular project meets sustainability criteria will always be a process requiring judgment and discretion.

It may also arise in some applications that a sustainable project might nevertheless pose some trade-off between its economic and its cultural valuation. For example, suppose two heritage investment projects are under consideration, and only one can be chosen. Project A may rank highly on economic outcomes but poorly in cultural terms; project B might be the reverse. Some way of representing society’s preferences between economic and cultural outcomes would be required in order to resolve the dilemma of choice. The point to be made is that it should not be assumed that, in such circumstances, the economic assessment should automatically dominate the decision, if the full concept of sustainable use of cultural capital is to be properly served.

---

## Case Studies: The Next Stage

This paper has laid out the theoretical basis upon which it is possible to interpret heritage as cultural capital and to assess its sustainability characteristics. The paper has also suggested some approaches to making these ideas operational. The empirical application of these approaches is to be tested by reference to several case studies of heritage projects. It is suggested that the key tasks of the case studies will be:

- to identify the asset characteristics of the cultural capital involved in the project
- to measure the components of the economic and cultural evaluations of the project
- to analyze the project's outcomes against the agreed criteria for sustainability
- to arrive at an overall conclusion integrating the economic and cultural values of the project

As far as possible, case studies should be chosen to cover a representative variety of project types, regions, political or institutional jurisdictions, and so on. Given the extensive research requirements needed to undertake a full economic analysis, the inclusion of one or more projects for which a comprehensive economic assessment has already been undertaken would seem to be desirable. In such cases, the case-study analysis could involve, first, a critical appraisal of the economic evaluation (are all costs and use and nonuse values included, and does it measure what it sets out to measure?) and, second, a review of existing work on the cultural value of the project (how successful is the cultural evaluation, and is it accorded appropriate weight in the final analysis?). The case study might then be able to propose ways of furthering the original analysis, especially by recasting it in a sustainability framework.

---

## Notes

The author is grateful to Michelle Lowe and Michael Tooma for research assistance in the preparation of this paper and to Randall Mason and Marta de la Torre for comments on an earlier draft. Responsibility for the views expressed, however, rests with the author.

1. For the purposes of this paper, cultural heritage is defined as movable artifacts, artworks, and other items such as are contained in museums and other collections, and immovable heritage such as archaeological sites, buildings, or groups of buildings, locations, precincts, etc., of historical or cultural importance (Throsby 1997b). For further discussion of the

definition of heritage, see contributions to Hutter and Rizzo (1997) and to Schuster, de Moncheaux, and Riley (1997); see also Prott (1998) and Klamer and Zuidhof (1999). For the cultural criteria used in World Heritage classification, see *Operational Guidelines for the Implementation of the World Heritage Convention* as promulgated by UNESCO.

2. See, for example, President's Committee on the Arts and the Humanities (1997).
3. See Throsby (1999); Barker (1999).
4. Some examples of cases where sustainability is seen as important from a heritage conservationist perspective are English Heritage (1997) and Rosvall (1999).
5. This distinction was originally created by Irving Fisher, who referred to the flow as "income" deriving from the capital stock; see Fisher (1927), 51ff.
6. The use of the term *cultural capital* in economics differs from the concept now widely used in sociology following Bourdieu (1986), where cultural capital refers to an individual's competence in high-status culture. Bourdieu's usage relates to characteristics of human beings and, as such, is very close to the economic concept of human capital (Becker 1964). For further discussion of the use of the term both within and beyond economics, see Throsby (1997a, 1999).
7. A *public good* is defined in economics as a good characterized by nonrivalness (one person's consumption does not diminish another's) and nonexcludability (once the good is provided for one person, it is available to all, and no one can be excluded from consuming it). National defense is often cited as a paradigmatic case of a pure public good.
8. The title of a recent World Bank report is suggestive of the distinction between cultural and economic value. The report, called *Very Special Places: The Architecture and Economics of Intervening in Historic Cities*, explicitly identifies architectural and economic values in the redevelopment of urban heritage in developing countries. See Serageldin (1999).
9. For further discussion of the relationship between economic and cultural value, see Throsby (2001), chapter 2.
10. There is an emerging literature on the accounting valuation of both movable and immovable cultural assets; see, for example, Carnegie and Wolnizer (1995) and Carman, Carnegie, and Wolnizer (1999).
11. See El Serafy (1991), Costanza and Daly (1997), Berkes and Folke (1992), Folke et al. (1994), Hinterberger et al. (1997), Wackernagel and Rees (1997), Barbier (1998, 65–95), and England (1998).
12. See n. 5.
13. The interactions between these systems and the economy should also be noted; see Throsby (1995).
14. For further discussion, see the references on the nature of natural capital cited in n. 11.
15. Note that Pearce (1988) argues that natural and manufactured capital are complements in the early stages of

economic growth but that they are substitutes at later stages, when natural capital is above a minimum threshold level.

16. Note that some counterexamples could be suggested—for example, where a historic building is replaced by a new one that has little or no cultural value initially but that, for one reason or another, acquires cultural status over time.
17. For a more detailed consideration of sustainability as it relates to a broad interpretation of culture, see Throsby (1995, 1997a).
18. Thus Solow (1986, 142) suggests that “whether productive capacity should be transmitted across generations in the form of mineral deposits or capital equipment or technological knowledge is more a matter of efficiency than of equity.”
19. Proops et al. (1999) extend the Pearce-Atkinson model to account for international trade; see also Rennings and Wiggering (1997).
20. Mourmouras (1993) points to other flaws in applying efficiency criteria to renewable resource allocation between generations.
21. Overviews of methodologies for measuring demand for nonmarket goods in a cultural heritage context can be found in Pagiola (1996), Frey and Oberholzer-Gee (1998), and Klamer and Zuidhof (1999).
22. See Mitchell and Carson (1989), Braden and Kolstad (1991), Hausman (1993), and Portney et al. (1994).
23. This source of bias may lead to overstatement of WTP. For example, if an individual is asked how much she would pay to a fund to preserve the Egyptian pyramids, then subsequently to similar funds for the Taj Mahal, the Great Wall of China, and the Leaning Tower of Pisa, the sum of all the nominated amounts may exceed an aggregate amount she would be prepared to contribute to heritage in general.
24. This approach was suggested by Bohm (1979) and was used, for example, by Throsby and Withers (1983) in a CVM study of WTP for the benefits of public support for the arts in Australia.
25. Applications of CVM to the evaluation of cultural projects include studies of the Musée de la Civilisation in Quebec (Martin 1994), the Royal Theatre in Copenhagen (Bille Hansen 1997), the “open museums” in Naples (Santagata and Signorello 1998), and the rehabilitation of Fez in Morocco (Agostini 1998).

## References

- Agostini, P. 1998. Valuing the invaluable: The case of the Fes-Medina. Paper given at the World Bank Conference on Culture in Sustainable Development, Washington, D.C., October 28.
- Arrow, K. J., et al. 1993. Report of the NOAA Panel on Contingent Valuation. *Federal Register* 58:4601–14.
- Barbier, E. B. 1998. *The Economics of Environment and Development: Selected Essays*. Cheltenham, U.K.: Edward Elgar.
- Barker, G. 1999. *Cultural Capital and Policy*. New Zealand Film Commission.
- Becker, G. S. 1964. *Human Capital*. New York: Columbia University Press.
- Becker, R. A. 1982. Intergenerational equity: The capital-environment trade-off. *Journal of Environmental Economics and Management* 9:165–85.
- Benhamou, F. 1998. The evolution of heritage policies. In Peacock 1998, 75–95.
- Berkes, F., and C. Folke. 1992. A systems perspective on the interrelations between natural, human-made, and cultural capital. *Ecological Economics* 5:1–8.
- Bille Hansen, T. 1997. The willingness-to-pay for the Royal Theatre in Copenhagen as a public good. *Journal of Cultural Economics* 21:1–28.
- Bohm, P. 1979. Estimating willingness to pay: Why and how? *Scandinavian Journal of Economics* 81:142–53.
- Bourdieu, P. 1986. Forms of capital. In *Handbook of Theory and Research for the Sociology of Education*, ed. J. G. Richardson, 241–60. New York: Greenwood.
- Braden, J. B., and C. D. Kolstad, eds. 1991. *Measuring the Demand for Environmental Quality*. Amsterdam: North Holland.
- Carman, J., G. D. Carnegie, and P. W. Wolnizer. 1999. Is archaeological valuation an accounting matter? *Antiquity* 73:143–48.
- Carnegie, G. D., and P. W. Wolnizer. 1995. The financial valuation of cultural, heritage, and scientific collections: An accounting fiction. *Australian Accounting Review* 5:31–47.
- Chanel, O., L.-A. Gerard-Varet, and V. Ginsburgh. 1996. The relevance of hedonic price indices: The case of paintings. *Journal of Cultural Economics* 20:1–24.
- Connor, S. 1992. *Theory and Cultural Value*. Oxford: Blackwell.
- Costanza, R., ed. 1991. *Ecological Economics: The Science and Management of Sustainability*. New York: Columbia University Press.
- Costanza, R., et al. 1997. The value of the world’s ecosystem services and natural capital. *Nature* 387/15.
- Costanza, R., and H. E. Daly. 1997. Natural capital and sustainable development. In *Frontiers in Ecological Economics*, ed. R. Costanza, 65–74. Cheltenham, U.K.: Edward Elgar.
- El Serafy, S. 1991. The environment as capital. In Costanza 1991, 168–75.
- . 1998. Pricing the invaluable: The value of the world’s ecosystem services and natural capital. *Ecological Economics* 25:25–27.

- England, R. W. 1998. Should we pursue measurement of the natural capital stock? *Ecological Economics* 27:257–66.
- English Heritage. 1997. *Sustaining the Historic Environment: New Perspectives on the Future*. London: English Heritage.
- Etlin, R. A. 1996. *In Defense of Humanism: Value in the Arts and Letters*. New York: Cambridge University Press.
- Fisher, I. 1927. *The Nature of Capital and Income*. New York: Macmillan.
- Folke, C., et al. 1994. Investing in natural capital—Why, what, and how? In Jansson et al. 1994, 1–20.
- Frey, B. S., and F. Oberholzer-Gee. 1998. Public choice, cost-benefit analysis, and the evaluation of cultural heritage. In Peacock 1998, 27–53.
- Frey, B. S., and W. W. Pommerehne. 1989. *Muses and Markets: Explorations in the Economics of the Arts*. Oxford: Basil Blackwell.
- Getty Conservation Institute (GCI). 1999. *Economics and Heritage Conservation: A Meeting Organized by the Getty Conservation Institute, December 1998*, ed. R. Mason. Los Angeles: Getty Conservation Institute.
- Hartwick, J. M. 1977. Intergenerational equity and the investing of rents from exhaustible resources. *American Economic Review* 67:972–74.
- . 1978a. Investing returns from depleting renewable resource stocks and intergenerational equity. *Economics Letters* 1:85–88.
- . 1978b. Substitution among exhaustible resources and intergenerational equity. *Review of Economic Studies* 45:347–54.
- Hausman, J. A., ed. 1993. *Contingent Valuation: A Critical Assessment*. Amsterdam: North Holland.
- Hinterberger, F., et al. 1997. Material flows vs. “natural capital”: What makes an economy sustainable? *Ecological Economics* 23:1–14.
- Hutter, M., and I. Rizzo, eds. 1997. *Economic Perspectives on Cultural Heritage*. London: Macmillan.
- Jansson, A. M., et al., eds. 1994. *Investing in Natural Capital—The Ecological Economics Approach to Sustainability*. Washington, D.C.: Island Press.
- Klamer, A., and P.-W. Zuidhof. 1999. The values of cultural heritage: Merging economic and cultural appraisals. In GCI 1999, 23–61.
- Martin, F. 1994. Determining the size of museum subsidies. *Journal of Cultural Economics* 18:255–70.
- Mitchell, R. C., and R. T. Carson. 1989. *Using Surveys to Value Public Goods: The Contingent Valuation Method*. Washington, D.C.: Resources for the Future.
- Moorhouse, J. C., and M. S. Smith. 1994. The market for residential architecture: Nineteenth-century row houses in Boston’s South End. *Journal of Urban Economics* 35:267–77.
- Mourmouras, A. 1993. Conservationist government policies and intergenerational equity in an overlapping generations model with renewable resources. *Journal of Public Economics* 51:249–68.
- Page, T. 1977. *Conservation and Economic Efficiency: An Approach to Materials Policy*. Baltimore: Johns Hopkins University Press.
- Pagiola, S. 1996. *Economic Analysis of Investment in Cultural Heritage: Insights from Environmental Economics*. Washington, D.C.: World Bank.
- Peacock, A. 1997. Towards a workable heritage policy. In Hutter and Rizzo 1997, 225–35.
- Peacock, A., ed. 1998. Does the Past Have a Future? *The Political Economy of Heritage*. London: Institute of Economic Affairs.
- Pearce, D. 1988. Economics, equity, and sustainable development. *Futures* 20:598–605.
- Pearce, D. W., and G. D. Atkinson. 1993. Capital theory and the measurement of sustainable development: An indicator of “weak” sustainability. *Ecological Economics* 8:103–8.
- Portney, P. R., et al. 1994. Contributions to a symposium on “contingent valuation.” *Journal of Economic Perspectives* 8:3–64.
- President’s Committee on the Arts and the Humanities (John Brademas, chair). 1997. *Creative America*. Washington, D.C.: National Endowment for the Arts.
- Proops, J. L. R., et al. 1999. International trade and the sustainability footprint: A practical criterion for its assessment. *Ecological Economics* 28:75–97.
- Prott, L. V. 1998. International standards for cultural heritage. In *World Culture Report: Culture, Creativity, and Markets*, 222–36. Paris: UNESCO.
- Rawls, J. 1972. *A Theory of Justice*. Oxford: Oxford University Press.
- Rennings, K., and H. Wiggering. 1997. Steps towards indicators of sustainable development: Linking economic and ecological concepts. *Ecological Economics* 20:25–36.
- Rosvall, J. 1999. The heritage restoration facing a new challenge: Sustained development. Paper presented at the International Congress on European Historical Heritage as Employment Generating Source, Caceres, Spain, April 28–30.
- Santagata, W., and G. Signorello. 1998. Contingent valuation and cultural policy design: The case of “Napoli Musei Aperti.” Paper presented at the Tenth International Conference on Cultural Economics, Barcelona, June 14–17.
- Schuster, J. M., J. de Monchaux, and C. Riley, eds. 1997. *Preserving the Built Heritage: Tools for Implementation*. Hanover, N.H.: University Press of New England.
- Serageldin, I. 1999. *Very Special Places: The Architecture and Economics of Intervening in Historic Cities*. Washington, D.C.: World Bank.
- Solow, R. M. 1974. Intergenerational equity and exhaustible resources. *Review of Economic Studies* 41:29–45.
- . 1986. On the intergenerational allocation of natural resources. *Scandinavian Journal of Economics* 88:141–49.
- . 1994. An almost practical step toward sustainability. In National Research Council, *Assigning Economic Value to Natural Resources*, 19–29. Washington, D.C.: National Academy Press.
- Throsby, D. 1990. Perception of quality in demand for the theatre. *Journal of Cultural Economics* 14:65–82. Reprinted in *Cultural Economics: The Arts, the Heritage, and the Media Industries*, ed. R. M. Towse, vol. 1, 254–71. Cheltenham, U.K.: Edward Elgar 1997.
- . 1995. Culture, economics, and sustainability. *Journal of Cultural Economics* 19:199–206.



- . 1997a. Sustainability and culture: Some theoretical issues. *International Journal of Cultural Policy* 4:7–20.
- . 1997b. Seven questions in the economics of cultural heritage. In Hutter and Rizzo 1997, 13–30.
- . 1999. Cultural capital. *Journal of Cultural Economics* 23:3–12.
- . 2001. *Economics and Culture*. Cambridge: Cambridge University Press.
- Throsby, D., and G. Withers. 1983. Measuring the demand for the arts as a public good: Theory and empirical results. In *Economics of Cultural Decisions*, ed. W. S. Hendon and J. L. Shanahan, 177–91. Cambridge, Mass.: Abt Books.
- Tietenberg, T. 1996. *Environmental and Natural Resource Economics*, 4th ed. New York: Harper Collins.
- Toman, M. 1998. Why not to calculate the value of the world's ecosystem services and natural capital. *Ecological Economics* 25:57–60.
- Wackernagel, M., and W. E. Rees. 1997. Perceptual and structural barriers to investing in natural capital: Economics from an ecological footprint perspective. *Ecological Economics* 20:3–24.
- World Commission on Culture and Development (WCCD). 1995. *Our Creative Diversity*. Paris: UNESCO.
- World Commission on Environment and Development (WCED). 1987. *Our Common Future*. Oxford: Oxford University Press.
- Young, R. 1992. Evaluating long-lived projects: The issue of inter-generational equity. *Australian Journal of Agricultural Economics* 36:207–32.



**Participants in the Meeting  
on the Economics of Heritage Conservation  
The Getty Conservation Institute  
March 10–11, 2000**

*Gustavo Araoz*

United States Committee, International Council  
on Monuments and Sites (US/ICOMOS)  
Washington, D.C., U.S.A.

*Erica Avrami*

The Getty Conservation Institute  
Los Angeles, California, U.S.A.

*Daniel Bluestone*

The School of Architecture  
University of Virginia  
Charlottesville, Virginia, U.S.A.

*Jon Calame*

World Monuments Fund  
New York, New York, U.S.A.

*Carolina Castellanos*

Heritage Management Consultant  
Mexico City, Mexico

*Richard A. Engelhardt*

Principal Regional Office for Asia and the Pacific  
UNESCO  
Bangkok, Thailand

*Setha M. Low*

Department of Environmental Psychology  
The Graduate School and University Center  
The City University of New York  
New York, New York, U.S.A.

*Randall Mason*

The Getty Conservation Institute  
Los Angeles, California, U.S.A.

*Susana Mourato*

T. H. Huxley School of Environment, Earth Science, and  
Engineering  
Imperial College of Science, Technology, and Medicine  
London, United Kingdom

*Eduardo Rojas*

Social Development Division  
Sustainable Development Department  
Interamerican Development Bank  
Washington, D.C., U.S.A.

*Theresa Satterfield*

Decision Research  
Vancouver, Canada

*Mona Serageldin*

Unit for Housing and Urbanization  
Graduate School of Design  
Harvard University  
Cambridge, Massachusetts, U.S.A.

*Jeanne Marie Teutonico*

The Getty Conservation Institute  
Los Angeles, California, U.S.A.

*David Throsby*

School of Economics and Financial Studies  
Macquarie University  
Sydney, Australia

*Marta de la Torre*

The Getty Conservation Institute  
Los Angeles, California, U.S.A.





THE GETTY  
CONSERVATION  
INSTITUTE